

OPERATING INSTRUCTIONS



TYPE 716-C

CAPACITANCE BRIDGE

716-C

GENERAL RADIO COMPANY

OPERATING INSTRUCTIONS

TYPE 716-C

CAPACITANCE BRIDGE

Form 681-K
November, 1959

G E N E R A L R A D I O C O M P A N Y
WEST CONCORD, MASSACHUSETTS, USA

TABLE OF CONTENTS

Section 1.0 INTRODUCTION	1
1.1 General	1
1.2 Range and Accuracy	1
Section 2.0 INSTALLATION	2
2.1 Accessories Supplied	2
2.2 Accessories Required	2
2.3 Connections	2
Section 3.0 MEASUREMENTS	2
3.1 Direct Reading Method	2
3.2 Substitution Method	4
3.3 Substitution Methods with External Standards	6
Section 4.0 SPECIAL MEASUREMENTS	7
4.1 Measurement of High Resistance	7
4.2 Measurement of Large Inductance	8
4.3 Partial Substitution Methods	8
4.4 Series Substitution Methods	9
4.5 Series Resistance Method	10
4.6 Parallel Resistance Method	10
Section 5.0 OTHER USES	11
5.1 Voltage Limits	11
5.2 Frequency Range	11
5.3 Measurement of Dielectrics	12
5.4 Measurement of Direct Capacitance	13
5.5 Guard Electrodes	14
5.6 Polarizing Voltage	15
Section 6.0 CONSTRUCTION	15
6.1 Electrical Circuit	15
6.2 Adjustments	15



SPECIFICATIONS

Ranges of Measurement

Capacitance, direct-reading: 100 pf to 1.1 μ f at 1 kc; 100 pf to 1150 pf at 100 cps, 10 kc, and 100 kc.

Capacitance, substitution: 0.1 pf to 1050 pf with the internal standard.

0.1 pf up to value of available standard with external standard.

Dissipation Factor, direct-reading: 0.00002 to 0.56.

Dissipation Factor, substitution:

$$0.00002 \text{ to } 0.56 \times \frac{C \text{ standard}}{C \text{ unknown}}$$

Accuracy

Capacitance, direct-reading: $\pm 0.1\% \pm (0.6 \text{ pf} \times \text{capacitance multiplier setting})$ when $D < 0.01$.

Capacitance, substitution: $\pm 1.2 \text{ pf}$

Dissipation Factor, direct reading: ± 0.0005 or $\pm 2\%$ of dial reading, whichever is larger.

Dissipation Factor: substitution: ± 0.00005 or $\pm 2\%$ for the change in D when the change is less than 0.06.

When D is greater than the limits given above, corrections must be made to maintain the stated accuracy. Formulae are supplied to make these corrections. A correction chart for the precision capacitor is also supplied which allows accuracy of substitution measurements of $\pm 0.05\%$ or $\pm 0.6 \text{ pf}$. A 110-point calibration is available, at extra charge, which allows substitution measurements to be made with an accuracy of $\pm 0.05\%$ or $\pm 0.2 \text{ pf}$.

Frequency Range: 30 cps to 300 kc. To maintain the accuracies stated above, the operating frequency must not differ from the range-selector frequency by more than a factor of three.

Zero Capacitance Across the Unknown Terminals: Ap-

proximately 1 pf (negligible in substitution measurements or direct measurements with the multiplier at 10 or higher).

Temperature and Humidity: Variations of temperature from 65 to 95 F have no significant effect on the accuracy of the bridge.

Precise measurements of dissipation factor should not be attempted when the bridge has been exposed to abnormally high relative humidity, unless it is first dried by heat or a desiccant.

Power Input: 1 watt, maximum, at GENERATOR terminals, which allows a maximum of 200 v at 1 kc, or 50 v at 60 cps. If the generator and detector connections are interchanged, 700 volts can be applied at 1 kc and lower.

Accessories Supplied: One TYPE 274-NL Shielded Patch Cord and one TYPE 874-R34 Patch Cord.

Accessories Required: Oscillator, high-impedance detector, and, for substitution measurements, a balancing capacitor. The TYPE 1210-C Unit RC Oscillator is recommended with the TYPE 1232-A Tuned Amplifier and Null Detector for measurements up to 100 kc. The TYPE 1302-A Oscillator can also be used. At low radio frequencies, a radio receiver is a satisfactory detector. The TYPE 1422 Precision Capacitor and the TYPES 505, 1409, and 1401 Fixed Capacitors are recommended as balancing capacitors.

Mounting: Relay-rack mounting or hardwood cabinet.

Dimensions: Relay-rack model: width 19, height 14 inches (485 by 360 mm), depth behind panel 9 inches (230 mm). Cabinet model: width 21 $\frac{3}{4}$, height 14 $\frac{1}{4}$, depth 11 $\frac{1}{4}$ inches (555 by 365 by 290 mm).

Net Weight: Relay-rack model, 44 $\frac{1}{2}$ pounds (20.5 kg); Cabinet model, 54 $\frac{1}{2}$ pounds (25 kg).

OPERATING INSTRUCTIONS

TYPE 716-C CAPACITANCE BRIDGE

SECTION 1.0 INTRODUCTION

1.1 GENERAL

The Type 716-C Capacitance Bridge is a Schering bridge which is direct reading in capacitance over the frequency range from 30 c to 300 kc and in dissipation factor at four specific frequencies, 100 c, 1 kc, 10 kc, 100 kc. The resistance balance is made by means of a variable capacitor connected across one of the ratio arms, as shown in Figure 1. Hence its reading in dissipation factor is proportional to the ratio of the applied frequency to the frequency for which the RANGE SELECTOR switch is set.

The bridge may also be used for all types of substitution measurements by the addition of a fixed or variable balancing capacitor. The direct-reading scales greatly simplify the necessary calculations for capacitance and dissipation factor.

1.2 RANGE AND ACCURACY

The ranges of the bridge in both capacitance and dissipation factor at a frequency of 1 kc are given in Table I for both direct-reading and substitution methods using internal standard. Minimum values are set by the direct-reading limits of the scales or by 1/5 of the smallest division. The direct-reading maximum value of capacitance at the other three specific frequencies is 1150 $\mu\mu\text{f}$.

Both the minimum and maximum values of dissipation factor are proportional to the ratio of the applied frequency to the frequency for which the RANGE SELECTOR switch is set. This ratio should not be less than 0.1 nor greater than 3. The resulting ranges are 0.000002 to 0.056 and 0.00006 to 1.68.

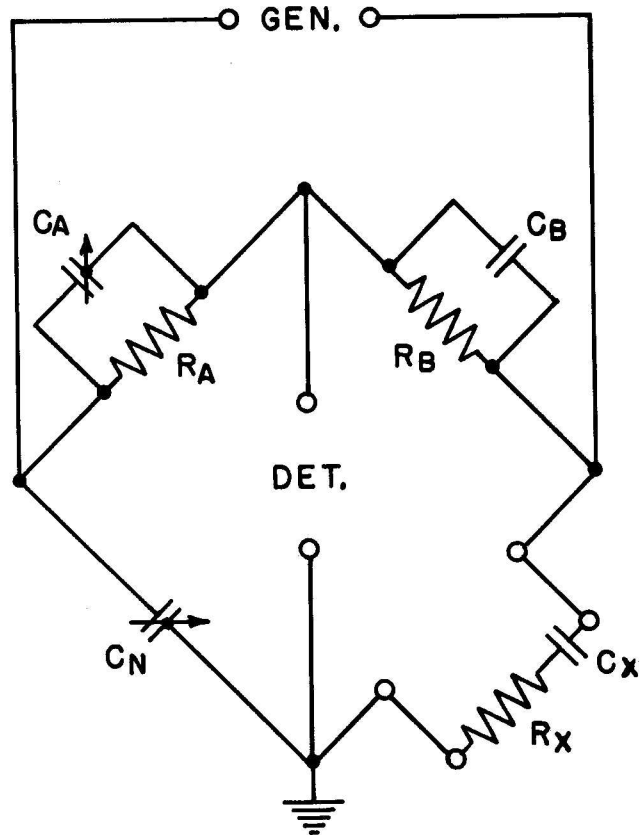

Figure 1. Schering Bridge Circuit.

TABLE I

Method	Quantity	Range at 1 kc		Error	
		Minimum	Maximum	Actual	Fractional
Direct Reading	C	100 $\mu\mu\text{f}$	1.1 μf	$(1\mu\mu\text{f} \times M) + 0.1\%$	0.2% } see 3.12
	D	0.00002	0.56		
Substitution	C	0.04 $\mu\mu\text{f}$	1050 $\mu\mu\text{f}$	2 $\mu\mu\text{f}$	0.2% } see 3.22
	D	$0.00002 \times \frac{C'}{C_x}$	$0.56 \times \frac{C'}{C_x}$	$0.00005 \times \frac{C'}{C_x}$	2 %

Dissipation factor, $D = \frac{R}{X} = R\omega C$, is numerically equal to power factor within 2% for all values less than 0.2.

M = capacitance setting of RANGE SELECTOR. C' = total capacitance in arm. C_x = unknown capacitance.

GENERAL RADIO COMPANY

SECTION 2.0 INSTALLATION

2.1 ACCESSORIES SUPPLIED

Two Type 274-NE Shielded Conductors are supplied with each Type 716-C Capacitance Bridge for connecting to the generator and detector.

Type 1301-A Low-Distortion Oscillator	20 c to 15 kc
Type 723-C Vacuum-Tube Fork	1000 c
Type 723-D Vacuum-Tube Fork	400 c

2.2 ACCESSORIES REQUIRED

A generator and detector are required to supply power to the bridge and detect the balance points. The Type 1302-A Oscillator and Type 1231-B Amplifier and Null Detector with 1231-P5 filter are recommended, since they most nearly cover the frequency range of the bridge. Other instruments with more limited frequency range and for both battery and a-c operation are given in the following tables.

DETECTORS

Type 1231-B Amplifier and Null Detector with the Type 1261-A Power Supply	10 c to 100 kc
Type 736-A Wave Analyzer	20 c to 16 kc
Type 1212-A Unit Null Detector	50 c to 5 Mc

BATTERY OPERATION

GENERATORS

(Battery-operated oscillators are generally available only for fixed audio frequencies, 1000 c and 400 c.)

Type 723-C Vacuum-Tube Fork (with batteries)	1000 c
Type 723-D Vacuum-Tube Fork (with batteries)	400 c

DETECTORS

Type 1231-B Amplifier and Null Detector	10 c to 100 kc
Type 760-B Sound Analyzer	25 c to 7500 c

(The Type 1231-B Amplifier and Null Detector with 1231-P5 Adjustable Filter is recommended.)

A-C OPERATION

GENERATORS

Type 1302-A Oscillator	10 c to 100 kc
Type 1304-A Beat-Frequency Oscillator	20 c to 20 kc
Type 1330 Bridge Oscillator	60 c, 400 c, 1 kc 5 kc to 50 Mc

2.21 All the detectors listed above include visual null indicators. Aural null indicators, such as head telephones can also be used with these or with other types of amplifiers. Western Electric 1002-C and Brush crystal telephones (or their equivalents in sensitivity and impedance) are satisfactory. When a visual indicator is desired, for use with amplifiers other than those listed above, the Type 1800 Vacuum-Tube Voltmeter, or the Type 1803 Vacuum-Tube Voltmeter will be found satisfactory.

2.22 Selectivity, which is inherent in magnetic telephones, must be provided for most detectors by tuned circuits or band-pass filters. The Type 1231-P2 and the Type 1231-P3 Tuned Circuits, the Type 1231-P5 Filter, and Type 830 Wave Filters are suitable. The Type 760 Sound Analyzer and Type 736 Wave Analyzer are in themselves highly selective.

2.3 CONNECTORS

Connect the generator and detector to the bridge by means of the Type 274-NE Shielded Conductors supplied, with the shield side of the conductors connected to the terminals marked G on all instruments. Connect one of these ground terminals, preferably one on the bridge, to a good ground, or to a large metal sheet placed under all three instruments. The bridge may be operated with its panel either horizontal or vertical.

2.4 HUMIDITY

During periods of high relative humidity, it may be desirable to use desiccators or raise the bridge temperature 20° C above ambient.* Humidity has little effect on capacitance accuracy, but can cause serious errors in dissipation factor readings.

SECTION 3.0 MEASUREMENTS

3.1 DIRECT READING METHOD

3.11 Procedure: Connect the capacitor to be measured to the UNKNOWN DIRECT terminals with its shield or ground side connected to the lower terminal marked G. Use as short leads as possible. The bridge will not balance unless a capacitance greater than 50 $\mu\mu\text{f}$ is connected across these terminals.

3.111 Set the METHOD switch at DIRECT. Set the DISSIPATION FACTOR switch at 0, unless it is known that the dissipation factor of the unknown capacitor is greater than 0.06. Set the RANGE SELECTOR switch to the frequency position nearest to that used and to *R.F. Field, "Heat Can Conquer Humidity," General Radio EXPERIMENTER, June, July, 1944.

TYPE 716-C CAPACITANCE BRIDGE

the capacitance position that shows the least unbalance of the bridge (only at a frequency position of 1 kc are there multiple capacitance positions). The gain of the amplifier should be turned down at first, so that overloading will not occur.

3.112 Adjust the CAPACITANCE and DISSIPATION FACTOR dials alternately until a sharp balance is obtained on both, readjusting the RANGE SELECTOR and DISSIPATION FACTOR switches if necessary. The capacitance balance usually must be made more closely than it can be read in order to obtain a dissipation factor balance to a tenth division on the dial.

3.113 The reading of the CAPACITANCE drum and dial (C) multiplied by the setting of the RANGE SELECTOR (M) gives the total capacitance across the UNKNOWN DIRECT terminals. This measured value includes the zero capacitance of 1.1 $\mu\mu\text{f}$ across those terminals. The unknown is:

$$C_{XS} = MC - 1.1 \quad (\mu\mu\text{f}) \quad (1)$$

3.114 One turn of the dial corresponds to 50 $\mu\mu\text{f}$. The last two figures of the capacitance reading to the left of the decimal point are either the actual dial reading or that reading increased by 50, depending on whether the reading of the drum is an even 100 or ends in 50. The dial and drum are direct reading only between 100 and 1150 $\mu\mu\text{f}$.

3.115 The dissipation factor of the unknown capacitor is the sum of the readings of the DISSIPATION FACTOR switch and dial multiplied by 0.01 times the ratio of the applied frequency f to the frequency setting f_0 of the RANGE SELECTOR switch.

$$D_x = 0.01 \frac{f}{f_0} D \quad (2)$$

When the factor 0.01 is omitted, dissipation factor is expressed in percent.

3.116 The series resistance of the unknown capacitor, its parallel capacitance, and its parallel resistance can be calculated from the expressions

$$\begin{aligned} R_{XS} &= \frac{D_x}{\omega C_{XS}} \\ C_{XP} &= \frac{C_{XS}}{1 + D_x^2} \\ R_{XP} &= \frac{1 + D_x^2}{D_x^2} R_{XS} = \frac{1 + D_x^2}{D_x \omega C_{XS}} \end{aligned} \quad (3)^*$$

*All formulae given in this booklet, except Equations (27) to (29), are consistent when the practical electro-magnetic units are used, ohm, henry, farad, cycle, radian with dissipation factor expressed as a ratio. Whenever these quantities appear as ratios, the units in which the bridge reads directly, micromicrofarads and dissipation factor, may be used. When these units are used in Equations (1), (2), (5), (6), (11), (12), (16), (17), (24), (25), and (26), the results are in the same units.

3.117 The fixed capacitances across the ratio arms A and B, represented in Figure 1 as C_B and the zero capacitance of C_A (Section 6.25), produce errors in both the capacitance and dissipation factor readings of the bridge, when the dissipation factor of the unknown capacitor is large. Approximate expressions applying to the unknown capacitor are

$$\begin{aligned} C_{XS} &= \frac{C}{1 + DD_0} \approx C - C(DD_0)** \\ D_x &= \frac{D}{1 + DD_0} \approx D - D(DD_0)** \\ R_{XS} &= \frac{D}{\omega C} \\ C_{XP} &= \frac{C}{1 + D^2} \frac{1}{1 + DD_0} \\ R_{XP} &= \frac{1 + D^2}{\omega DC} (1 + 2DD_0) \end{aligned} \quad (4)$$

where C and D are the values of C_{XS} and D_x calculated from Equations (1) and (2) and where D_0 is the dissipation factor corresponding to the fixed capacitance across each ratio arm, amounting to 205 $\mu\mu\text{f} + 5\%$ when the METHOD switch is set at DIRECT. The corresponding value of D_0 is $0.026 \frac{f}{f_0} \pm 5\%$. Both bridge readings are high by the factor $1 + DD_0$. In order to realize the maximum accuracy of the bridge, Equations (4) should be used for capacitance when $D > 0.01$, for parallel resistance when $D > 0.05$ and for dissipation factor when $D > 0.1$. The expression for series resistance is not subject to this kind of error. Values of the correction term DD_0 for different values of D are given in Table II.

**TABLE II
PERCENTAGE ERROR (when $\frac{f}{f_0} = 1$)
(When D reads value in table, C and D read too high by % in DD_0 column)

D	DD ₀ %	D	DD ₀ %
.05	.13	.35	.91
.10	.26	.40	1.04
.15	.39	.45	1.17
.20	.52	.50	1.30
.25	.65	.55	1.43
.30	.78	.60	1.56

3.12 Accuracy: The accuracy of the DIRECT capacitance reading is $\pm 0.1\% \pm (1 \mu\mu\text{f} \times \text{RANGE SELECTOR } M)$ over the range of 100 $\mu\mu\text{f}$ to 1.15 μf , provided the dissipation factor reading is less than 0.01 (see 3.122). This accuracy can be maintained for greater dissipation factor readings by using Equations (4).

3.121 The fractional accuracy, therefore, varies from 0.2% for full-scale setting of the CAPACITANCE dial to 1.1% for a setting of 100 $\mu\mu\text{f}$.

3.122 The CAPACITANCE dial itself is direct reading to $1 \mu\text{mf}$. The possible additional error of 0.1% can be introduced by the ratio arms, which are adjusted to better than $\pm 0.1\%$, plus small leakage impedances in the shielded transformer.

An extension of the ratio-arm shield projects through the panel into the insulator of the high UNKNOWN DIRECT terminal. There remains a capacitance of $1.1 \mu\text{mf}$ between this terminal and ground, which cannot conveniently be removed by shielding. The error caused by this capacitance must be eliminated by subtracting $1.1 \mu\text{mf}$ from the product of CAPACITANCE reading \times RANGE SELECTOR M to maintain the stated accuracy of $\pm 0.1\% + (1 \mu\text{mf} \times \text{RANGE SELECTOR M})$. (This latter error is, therefore, $1.1 \mu\text{mf}$ for $M = 1$, $0.11 \mu\text{mf}$ for $M = 10$, and negligible for $M = 100$ or 1000 .)

3.123 The leads used to connect the unknown capacitor to the terminals will add some capacitance. This introduces a positive error which must be subtracted from the bridge reading. The capacitance of leads of No. 16 bare wire with 3/4-inch spacing is about $0.3 \mu\text{mf}$ per inch. Most of this capacitance is associated with the high lead, which therefore should not be insulated. It will amount to $1.2 \mu\text{mf}$ for the shortest possible leads used when the panel of the unknown capacitor is flush with and touching the panel of the bridge. This capacitance may be measured as described in Section 3.2.

3.124 The accuracy of the dissipation factor readings is 0.0005 or 2%, whichever is the greater, provided the dissipation factor reading is less than 0.1. This accuracy can be maintained for greater dissipation factor readings by using Equations (4). It is difficult to state

exactly how the error varies over the dissipation factor range from zero to .06 because the scale of the DISSIPATION FACTOR dial is semi-logarithmic. Slight errors also arise from leakage impedances in the shielded transformer. The mica capacitors controlled by the DISSIPATION FACTOR switch are so adjusted that the accuracy of the switch settings is 1%.

3.125 The dissipation factor of the standard capacitor varies from 0.00004 at $1000 \mu\text{mf}$ to 0.0004 at $100 \mu\text{mf}$, corresponding to a figure of merit DC of $0.04 \mu\text{mf}$. The error in dissipation factor reading can be reduced by adding this dissipation factor of the standard capacitor. One of the capacitances of the shielded transformer is connected across the B arm as shown in Figure 10, and has an appreciable temperature coefficient of capacitance. The accuracy of the dissipation factor reading can be checked by the method suggested in Section 6.25.

3.2 SUBSTITUTION METHOD

3.21 Procedure: Many of the errors inherent in direct readings across the bridge may be eliminated by using the substitution method in which the standard air capacitor is always kept in circuit and the unknown capacitor is substituted for part of it. The capacitance range of this method is that of the standard capacitor, $1050 \mu\text{mf}$.

3.211 Set the METHOD switch at SUBSTITUTION and the RANGE SELECTOR switch to the frequency* position nearest to that used and to a capacitance position for M equal to 1. Connect a balancing capacitor to the UNKNOWN DIRECT terminals. The following method of connection** should give the capacitance added to the bridge by the unknown capacitor within 0.1 or $0.2 \mu\text{mf}$. Connect the low terminal of the unknown capacitor to the grounded UNKNOWN SUBSTITUTION terminal, as shown in Figure 2, leaving the high lead separated from the terminal of the unknown capacitor by about 1/4 inch. Make this lead a stiff bare wire of small diameter. Balance the bridge for capacitance and dissipation factor as described in Section 3.1. This balancing capacitor must be at least $100 \mu\text{mf}$ larger than the unknown capacitor and may be either fixed or variable. Type 505 Capacitors, Type 509 Standard Capacitors, and Type 722 Precision Capacitors are suitable+. With the METHOD switch set at SUBSTITUTION the capacitors controlled by the DISSIPATION FACTOR switch and dial are connected across the B arm.

3.212 Connect the high lead to the high terminal of the unknown capacitor and rebalance the bridge. The new reading for capacitance will be less than, and the new reading for dissipation factor will be greater than, the initial readings.

3.213 When the unknown capacitor has a dissipation factor less than 0.1, its capacitance and dissipation

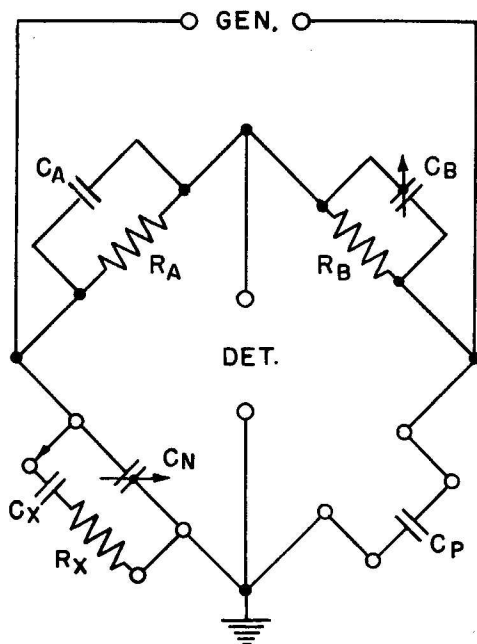

Figure 2. Substitution Method.

*Higher f_0 gives best resolution.

**J. F. Hersh, "A Close Look at Connection Errors in Capacitance Measurements", GENERAL RADIO EXPERIMENTER, July, 1959.

+See the General Radio catalog for data.

TYPE 716-C CAPACITANCE BRIDGE

factor can be calculated from the changes in readings of the CAPACITANCE and DISSIPATION FACTOR dials.

$$C_x = \Delta C \tag{5}$$

$$D_x = \frac{C'}{\Delta C} (\Delta D)$$

where initial readings are designated by primes and Δ stands for "change in".

$$\Delta C = C' - C \tag{6}$$

$$\Delta D = (D - D') \frac{f}{f_0}$$

The initial capacitance C' appearing in the dissipation factor equation should include the capacitance of the leads to the unknown capacitor. This capacitance may be found by making a third bridge balance in which the leads are removed. The change in reading of the CAPACITANCE dial from its initial reading is the lead capacitance. The losses in the standard capacitor do not appear in the expression for dissipation factor because these losses are constant and are in circuit at all times.

3.214 When the balancing capacitor is variable, the CAPACITANCE dial may be set exactly at a multiple of 100 $\mu\mu\text{f}$. The change in capacitance ΔC may then be read directly by reading the scale backward.

3.215 The series resistance and parallel resistance of the unknown capacitor can be calculated by means of Equations (3) or obtained directly from the expressions

$$R_{xs} = \frac{C'(\Delta D)}{\omega(\Delta C)^2} \tag{7}$$

$$R_{xp} = \frac{1}{\omega C'(\Delta D)}$$

where ΔD has already been multiplied by the frequency ratio f/f_0 .

3.216 The calibration of the DISSIPATION FACTOR dial is extended below zero to 0.0015 so that the bridge can be balanced initially even when the dissipation factor of the balancing capacitor is greater than that of the standard capacitor in the bridge. Advantage may also be taken of this negative calibration in allowing substitution measurements to be made with the METHOD switch set at DIRECT. For this connection the dissipation factor reading with the unknown connected will be less than the corresponding initial reading.

3.217 When the dissipation factor of the unknown capacitance is greater than 0.1 and the dissipation factor reading of the bridge is less than 0.1, Equations (5) and (7) require certain correction terms and become:

$$C_{xs} = \Delta C \frac{1 + (\Delta D)^2 \left(\frac{C}{\Delta C}\right)^2}{1 - (\Delta D)^2 \frac{C}{\Delta C}}$$

$$D_x = \frac{C'}{\Delta C} \frac{\Delta D}{1 - (\Delta D)^2 \frac{C}{\Delta C}}$$

$$R_{xs} = \frac{C'}{\omega(\Delta C)^2} \frac{\Delta D}{1 + (\Delta D)^2 \left(\frac{C}{\Delta C}\right)^2} \tag{8}$$

$$C_{xp} = \Delta C \frac{1 - (\Delta D)^2 \frac{C}{\Delta C}}{1 + (\Delta D)^2}$$

$$R_{xp} = \frac{1 + (\Delta D)^2}{\omega C'(\Delta D)}$$

where ΔD has already been multiplied by the frequency ratio f/f_0 .

3.218 When the dissipation factor of the unknown capacitor is very large (a value of 1 is a good dividing line), the zero capacitance of the ratio arm containing the DISSIPATION FACTOR capacitors produces additional errors, and the following expressions should be used:

$$C_{xs} = \Delta C \frac{1 + a^2}{1 + aD}$$

$$D_x = \frac{C'}{\Delta C} \frac{\Delta D}{1 + aD}$$

$$R_{xs} = \frac{C'}{\omega(\Delta C)^2} \frac{\Delta D}{1 + a^2} \tag{9}$$

$$C_{xp} = \Delta C \frac{1 + aD}{1 + D^2}$$

$$R_{xp} = \frac{1 + D^2}{\omega C'(\Delta D)}$$

$$\text{where } a = D_1' - \frac{C}{\Delta C} \Delta D = D_1' - \frac{C'}{\Delta C} \Delta D,$$

where ΔD has already been multiplied by the frequency ratio f/f_0 , and where

$$D_1' = (D' + D_0)f/f_0 \text{ and } D_1 = (D + D_0)f/f_0$$

With the METHOD switch in the SUBSTITUTION position, a capacitance of 65 $\mu\mu\text{f}$ is added across each ratio arm, which makes D_0 equal 0.034 $\frac{f}{f_0} \pm 5\%$.

3.219 If Equations (8) and (9) are checked by applying Equations (3) to the series quantities in order to obtain the parallel quantities, considerable difficulty will be encountered until the existence of the following identity is established,

$$1 + D_x^2 = (1 + D^2) \frac{1 + a^2}{(1 + aD)^2} \quad (10)$$

3.22 Accuracy: The accuracy of the calculated capacitance is $2 \mu\mu f$ or 0.2%, whichever is the greater, over the range up to $1050 \mu\mu f$, provided the dissipation factor of the unknown capacitance is less than 0.1 and ΔD is less than 0.06. This accuracy can be maintained for greater dissipation factors by using Equations (8) or (9). This error is double that of the standard capacitor because in a substitution measurement two readings are taken and the errors of these two readings may be additive.

3.221 A chart* is provided on the panel of the bridge giving the correction, in tenths $\mu\mu f$, to the standard capacitor for every $100 \mu\mu f$. The correction at the $50 \mu\mu f$ points can be obtained by interpolation. The worm correction is rarely greater than $0.25 \mu\mu f$. Application of this correction will allow capacitance differences to be determined to $\pm 0.8 \mu\mu f$ or $\pm 0.1\%$. For capacitance differences of less than $25 \mu\mu f$, this error decreases linearly to about $0.1 \mu\mu f$. The lower limit of this error may be set at $1/5$ of the smallest division or $0.04 \mu\mu f$, or by the backlash of the worm drive, which is not greater than $1/2$ of the smallest division or $0.1 \mu\mu f$.

3.222 The standard capacitor can be calibrated so as to be internally consistent to $0.1 \mu\mu f$ or 0.1%. This is the so-called worm correction.** Using the correction supplied by this calibration, capacitance can be measured to an accuracy of $0.2 \mu\mu f$ or 0.1%. A capacitance of $200 \mu\mu f$ is the smallest that can be measured to an accuracy of 0.1%.

3.223 The accuracy of the calculated dissipation factor is $0.00005 \times \frac{C'}{C_x}$ or 2% whichever is the greater, provided the dissipation factor of the unknown capacitor is less than 0.1 and ΔD is less than 0.06. This accuracy can be approximately maintained for greater dissipation factors by using Equations (8) or (9). The error is always that of the change in DISSIPATION FACTOR readings. This change can frequently be increased by keeping the capacitance ratio $\frac{C}{C_x}$ near unity and by making the frequency ratio $\frac{f}{f_0}$ less than unity. The minimum error indicated above can only be attained by using that part of the scale around zero. The dissipation factor of a mica capacitor, 0.0005, may thus be measured to an accuracy approaching 10%.

*R. F. Field, "Increased Accuracy for the Precision Condenser", General Radio EXPERIMENTER, June, 1947.

**See General Radio catalog for data.

3.3 SUBSTITUTION METHODS WITH EXTERNAL STANDARDS

3.31 An external Type 722 Precision Capacitor can be used as a standard by connecting it across the UNKNOWN DIRECT terminals and using the internal capacitor merely as a balancing capacitor. The METHOD switch is set at DIRECT. The use of such an external standard is of advantage only when this standard is provided with a worm correction or has a capacitance range especially suited to the work in hand.

3.311 Some of the advantages of the substitution method may be extended to capacitances greater than $1000 \mu\mu f$ whenever capacitance standards are available which are approximately equal to the unknown capacitor, but only at frequencies near 1 kc where the larger capacitance ranges are available. There are two different methods which use, respectively, the standard capacitor in the bridge and an external standard variable air capacitor.

3.32 Method I - Internal Variable Standard

3.321 With the METHOD switch set at DIRECT, connect the fixed capacitance standard to the UNKNOWN DIRECT terminals and balance the bridge for capacitance and dissipation factor. Substitute the unknown capacitor for the standard capacitor, using the same leads, and rebalance the bridge. The capacitance and dissipation factor of the unknown are:

$$C_x = C_s + (C - C') M \quad (11)$$

$$D_x = D_s + (D - D')$$

where the primes refer to the initial balance with the standard, M is the setting of the RANGE SELECTOR switch, and C_s and D_s are the capacitance and dissipation factor of the fixed standard.

3.322 The accuracy of this comparison is determined by the difference in capacitance between standard and unknown. When $C - C'$ is less than $5 \mu\mu f$, the errors in both capacitance and dissipation factor are almost entirely those of reading the two dials, as explained in Section 3.22: $0.1 \mu\mu f$ for capacitance and 0.00005 for dissipation factor. The former corresponds to a fractional error of 0.1% at the smallest setting of the standard capacitor which would ever be used, $100 \mu\mu f$.

3.323 By setting up tolerances for both the CAPACITANCE and DISSIPATION FACTOR dials, the bridge may be used as a limit bridge for rapidly checking lots of similar capacitors.

3.324 A set of fixed standard capacitors may be intercompared, provided there are enough duplicates so that each capacitor may be matched by those smaller than itself. A convenient set of standards consists of pairs of capacitors having values 1, 2, 5 per decade. The number of capacitors per decade may be reduced from six to four, a 1, two 2's and a 5, provided that an extra 1 is available in the lowest decade and no error is entail-

TYPE 716-C CAPACITANCE BRIDGE

ed in stacking four capacitors. Type 1409 Standard Capacitors are available in these ranges.* The two 1's are compared with the 2's; two 2's and a 1 with the 5's; two 5's with the 1's in the next decade and so on. Any capacitor in the set may be taken as correct or their average may be used as a reference. Their dissipation factors may be determined by measuring the dissipation factor of the 0.001- μ f standard by the substitution method of Section 3.2. Intercomparisons of this nature are probably consistent to 0.1% in capacitance and to 0.00005 in dissipation factor, and may be extended to well above 1 μ f.

3.325 Greater accuracy can be attained on the whole intercomparison if, when it would become necessary to change to the 10 multiplier in order to measure the 2000 μ f capacitors, the multiplier is kept at 1 and enough capacitance is added in parallel with the internal standard capacitor to provide the capacitance balance. This addition process is continued through the 10,000 μ f level. The multiplier is then changed to 10 and the process repeated. In this manner a consistency of 0.02% in capacitance can be attained. This accuracy can be maintained when $C - C'$ is greater than 5 μ f by the use of the worm correction.* Although the worm calibration is not intended for use when measurements are made at the UNKNOWN DIRECT terminals, it is valid when $C - C'$ is small.

3.33 Method II - External Variable Standard

3.331 With the METHOD switch set at DIRECT, connect the fixed capacitance standard to the UNKNOWN DIRECT terminals together with an external standard variable air capacitor and balance the bridge for capacitance and dissipation factor. The Type 722-D Precision Capacitor is suitable for this use*. The standard capacitor in the bridge is used merely as a balancing capacitor. It is, however, equivalent to a three-decade capacitor plus a variable air capacitor, because of the possibility of using any one of the four ratio arms controlled by the

*See General Radio catalog for data.

RANGE SELECTOR switch. Substitute the unknown capacitor for the fixed standard capacitor, using the same leads, and rebalance the bridge, making the capacitance balance by means of the external standard variable air capacitor. The capacitance and dissipation factor of the unknown are:

$$C_x = C_s + (C' - C) \tag{12}$$

$$D_x = D_s \frac{C_s}{C_x} + (D - D') \frac{C' + C_s}{C_x}$$

where C' and C refer to the initial and final capacitances of the external standard air capacitor respectively, and C_s and D_s are the capacitance and dissipation factor of the fixed standard.

3.332 The accuracy of this comparison is determined by the difference in capacitance between standard and unknown. For capacitances of 1000 μ f or less the error is the same as stated in Method I. For larger capacitances the error in capacitance is less than occurs in Method I because the external standard air capacitor, by means of which the capacitance difference is taken up, is a small fraction of the total capacitance. In general, the error is 2 μ f for the direct reading calibration of a 1000- μ f external air condenser, 0.8 μ f if the panel chart is used, and 0.2 μ f if a worm correction is supplied. The error is 0.00005 for dissipation factor as before.

3.333 A set of fixed standard capacitors may be intercompared in the same manner as with Method I. These intercomparisons are probably consistent to 0.02% in capacitance and to 0.00005 in dissipation factor. The extra complications of Equation (12) for dissipation factor are such that the modified Method I, which has equal accuracy, is preferred for routine intercomparisons.

SECTION 4.0 SPECIAL MEASUREMENTS

4.1 MEASUREMENT OF HIGH RESISTANCE

4.11 A high resistance may be measured by the substitution method described in Section 3.2. The unknown resistor is connected across the UNKNOWN SUBSTITUTION terminals by short bare leads. Its dissipation factor, series and parallel capacitance, and series and parallel resistance are given by Equation (9).

4.12 If the resistor has no reactive component so that

$$C_{xs} = \infty \quad \text{and} \quad C_{xp} = 0$$

its series resistance is the same as its parallel resistance as given by Equation (9). There will still be a change of capacitance of the standard capacitor given by

$$\Delta C = \frac{C'D(\Delta D)}{1 + D^2} = \frac{CD(\Delta D)}{1 + DD'} \tag{13}$$

where ΔD has already been multiplied by the frequency ratio f/f_0 and where the dissipation factor readings D and D' must be increased by $D_0 = 0.034$ before being multiplied by the frequency ratio f/f_0 .

4.13 A change of capacitance less than this value, zero, or of opposite sign implies that the resistor is inductive. Its series and parallel inductances are

$$L_{xs} = - \frac{1}{\omega^2 C_x} \tag{14}$$

$$L_{xp} = - \frac{1}{\omega^2 C_{xp}}$$

4.14 The largest resistance that can be detected, corresponding to a change in dissipation factor of 0.00002 is 80 k Ω , with the standard capacitor set at 100 μ f.

The smallest measurable resistance corresponding to a change of dissipation factor of 0.56, the full range of the DISSIPATION FACTOR switch and dial, is 300 kΩ, with the standard capacitor set at 1000 μμf. These limits hold for a frequency of 1 kc. The range in resistance varies inversely with the frequency, as shown in Table III.

TABLE III

f ₀	Resistance		Inductance	
	min	max	min	max
100 c	3 MΩ	800 kMΩ	2.5 kh	100 Mh
1 kc	300 kΩ	80 kMΩ	25 h	1 Mh
10 kc	30 kΩ	8 kMΩ	250 mh	10 kh
100 kc	3 kΩ	800 MΩ	2.5 mh	100 h

4.15 The decrease in resistance of high-valued resistors, both wire wound and metallized, with increase in frequency may be studied by this method. This is the Boella effect, which is caused by distributed capacitance and its dissipation factor.

4.2 MEASUREMENT OF LARGE INDUCTANCE

4.21 A large inductance may be measured by the substitution method described in Section 3.2. The unknown inductor is connected across the UNKNOWN SUBSTITUTION terminals in the same manner as an unknown capacitor. The change in capacitance ΔC will in general be negative, the final reading of the CAPACITANCE dial with the inductor connected being greater than its initial reading. Hence the balancing capacitance must be less than 1150 μμf by at least the amount ΔC.

4.22 The dissipation factor, series and parallel resistances, and equivalent series and parallel capacitances of the unknown inductor are given by Equations (5) and (7). Its series and parallel inductances can be calculated by Equations (14). For large values of dissipation factor it will be necessary to use Equations (9). Its storage factor is the reciprocal of its dissipation factor.

$$Q_x = \frac{1}{D_x} \tag{15}$$

4.23 The inductance range extends from 25 h to 1 Mh (1,000,000 h), corresponding to changes in capacitance of 1000 μμf and 0.02 μμf respectively at a frequency of 1 kc. The range in inductance varies inversely with the square of the frequency, as shown in Table III.

4.24 The changes in the parallel resistance and reactance of a choke coil or parallel tuned circuit as the frequency is carried through resonance may be studied by this method. The corresponding values of dissipation factor may be calculated and the distributed capacitance determined.

*See General Radio catalog for data.

4.3 PARTIAL SUBSTITUTION METHODS

The lower limit for the measurement of both resistance and inductance by the method described in Sections 4.1 and 4.2 may be made much smaller by using either of the two methods of Sections 3.32 and 3.33 but only at frequencies near 1 kc where the larger capacitance ranges are available.

4.31 For Method II, in which an external standard variable air capacitor is used, Equations (5) to (9) hold unchanged. The lower limit of resistance is reduced to 300 Ω, with a total capacitance in circuit of 1 μf. Type 509 Standard Capacitors may be used as external fixed standards.* The lower limit of inductance is still 25 h, corresponding to a change in capacitance of 1000 μμf, the range of the external precision capacitor.

4.32 For Method I, in which the bridge is balanced for capacitance by means of the internal standard air capacitor, the procedure is modified to the extent that the fixed balancing capacitance is kept in circuit at all times. Equations (5) to (9) must be modified by transposing C and C' wherever they appear, and multiplying them by M, the capacitance setting of the RANGE SELECTOR switch.

4.321 For small values of dissipation factor of the unknown capacitor

$$C_{XS} = M(\Delta C) \tag{16}$$

$$D_x = \frac{C}{\Delta C} \frac{f}{f_0} \Delta D$$

where

$$\Delta C = C - C' \tag{17}$$

$$\Delta D = D - D'$$

also

$$R_{XS} = \frac{C(\Delta D)}{M\omega(\Delta C)^2}$$

$$** R_{xp} = \frac{1}{\omega M C(\Delta D)} \tag{18}$$

where ΔD has already been multiplied by the frequency ratio f/f₀.

4.322 For large values of dissipation factor of the unknown capacitor

$$C_{XS} = M(\Delta C) \frac{1 + b^2}{1 + bD}$$

$$D_x = \frac{C}{\Delta C} \frac{\Delta D}{1 + bD}$$

**For best accuracy, replace

$$MC \text{ by } MC - 1.1 \tag{\mu\mu f}$$

$$MC'C \text{ by } M \left(C' - \frac{1.1}{M} \right) \left(C - \frac{1.1}{M} \right) \tag{\mu\mu f}$$

especially when M = 1 and C is small.

TYPE 716-C CAPACITANCE BRIDGE

$$R_{XS} = \frac{C}{\omega M(\Delta C)^2} \frac{\Delta D}{1 + b^2} \quad (19)$$

$$C_{XP} = M(\Delta C) \frac{1 + bD}{1 + D^2}$$

$$** R_{XP} = \frac{1 + D^2}{\omega M C(\Delta D)}$$

$$\text{where } b = D' - \frac{C'}{\Delta C} \Delta D = D - \frac{C}{\Delta C} \Delta D,$$

where ΔD has already been multiplied by the frequency ratio f/f_0 , and where D and D' have been increased by D_0 before being multiplied by f/f_0 . Since the METHOD switch will be in the DIRECT position, D_0 equals 0.026 ± 5%.

The lower limit of resistance is reduced to 300Ω, for a total capacitance in circuit of 1μf. The lower limit of inductance is reduced to 25 mh for a change in capacitance of 1μf. This limit varies inversely as the square of the frequency. Both Type 505 Capacitors and Type 509 Standard Capacitors may be used as the fixed balancing capacitors.*

4.4 SERIES SUBSTITUTION METHODS

4.41 Capacitances greater than those that can be measured by parallel substitution methods may be measured by connecting them in series with a fixed balancing capacitor across the UNKNOWN DIRECT terminals. The balancing capacitor is first measured alone by the method of Section 3.1. The unknown capacitor is then connected in series between the balancing capacitor and the ground terminal. Its series capacitance, dissipation factor, and series resistance are

$$** C_{XS} = \frac{MC'C}{\Delta C}$$

$$D_X = \frac{DC' - D'C}{\Delta C} \quad (20)$$

$$** R_{XS} = \frac{DC' - D'C}{\omega MC'C}$$

where D and D' have already been multiplied by the frequency ratio f/f_0 .

4.411 The largest capacitance that can be detected is 50mf (0.05f) for a fixed capacitance of 1 μf or 50 μf for a fixed capacitance of 1000 μμf for $M = 1$ and a change in capacitance of the standard air capacitor of 0.02 μμf.

4.412 When the dissipation factor reading with the unknown capacitor connected is greater than 0.1, the fixed capacitances across the ratio arms A and B

introduce sufficient errors so that Equations (20) must be modified.

$$** C_{XS} = \frac{MC'C}{\Delta C + (DC' - D'C)D_0}$$

$$D_X = \frac{DC' - D'C}{\Delta C + (DC' - D'C)D_0} \quad (21)$$

$$** R_{XS} = \frac{DC' - D'C}{\omega MC'C}$$

where D_0 is the dissipation factor corresponding to the fixed capacitances across the ratio arms and has the value 0.026 f/f_0 .

4.42 Small inductances may be measured by this method. As with capacitances, the inductor is connected in the ground lead of the fixed balancing capacitor. Its series inductance, dissipation factor, series resistance, and storage factor are

$$** L_{XS} = \frac{\Delta C}{\omega^2 MCC'}$$

$$D_X = \frac{DC' - D'C}{\Delta C}$$

(22)

$$** R_{XS} = - \frac{DC' - D'C}{\omega MC'C}$$

$$Q_X = \frac{\Delta C}{DC' - D'C}$$

where D and D' have already been multiplied by the frequency ratio f/f_0 .

4.421 The smallest inductance that can be detected at a frequency of 1 kc is 0.5 μh for a fixed capacitance of 1 μf, or 500 μh for a fixed capacitance of 1000 μμf, for $M = 1$ and a change in capacitance of the standard capacitor of 0.02 μμf. This limit varies inversely as the square of the frequency.

4.422 When the dissipation factor reading with the unknown inductor connected is greater than 0.1, the fixed capacitances across the ratio arms A and B introduce sufficient errors so that Equations (22) must be modified.

$$** L_X = - \frac{\Delta C + (DC' - D'C)D_0}{\omega^2 MC'C}$$

$$D_X = \frac{DC' - D'C}{\Delta C + (DC' - D'C)D_0}$$

(23)

$$** R_X = - \frac{DC' - D'C}{\omega MCC'}$$

$$Q_X = \frac{\Delta C + (DC' - D'C)D_0}{DC' - D'C}$$

*See General Radio catalog for data.

**See note, page 8.

where D_0 is the dissipation factor corresponding to the fixed capacitances across the ratio arms and has the value $0.026 f/f_0 \pm 5\%$.

4.43 The ranges for both capacitance and inductance may be extended by connecting a standard variable air capacitor in parallel with the fixed balancing capacitor as indicated in Section 3.33. Equations (20) to (23) hold except that C and C' are transposed. The limits for capacitance and inductance at a frequency of 1 kc are 1 f and 0.025 μ h, based on a sensitivity of capacitance balance of 1 part per million.

4.5 SERIES RESISTANCE METHOD

4.51 The series resistance of a capacitor having a capacitance of 1000 $\mu\mu$ f or less may be measured by modifying the substitution method of Section 3.2, as shown in Figure 3. The resistance balance is made by means of a decade resistor such as a Type 1432 Decade Resistance Box*, connected in the ground lead of the balancing capacitor.

If the initial resistance balance is made by means of the DISSIPATION FACTOR dial, leaving the decade resistor set at zero when the unknown capacitor is not connected, the change in resistance is the setting of this decade resistor for the second balance. The series capacitance and series resistance of the unknown capacitor are

$$C_{XS} = \Delta C$$

$$R_{XS} = \left(\frac{C'}{\Delta C}\right)^2 \Delta R \tag{24}$$

4.511 Since the change in resistance corresponding to a change in dissipation factor of 0.00002 is much greater than 0.1 Ω , smaller changes in dissipation factor

*See General Radio catalog for data.

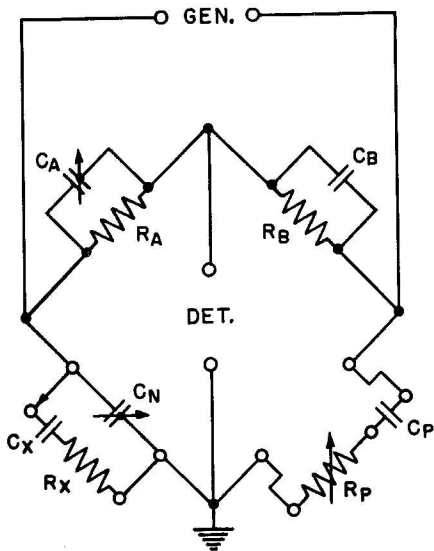

Figure 3. Substitution Series-Resistance Method.

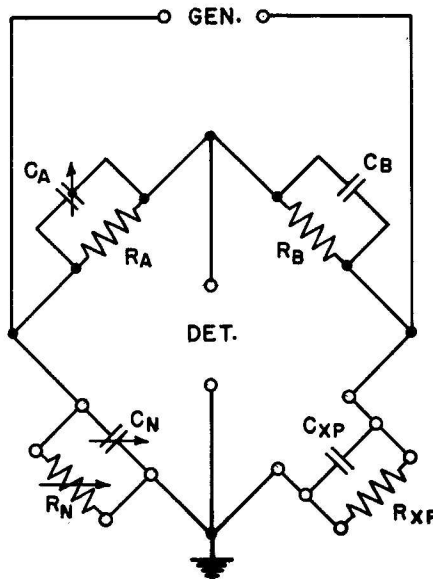

Figure 4. Parallel-Resistance Method.

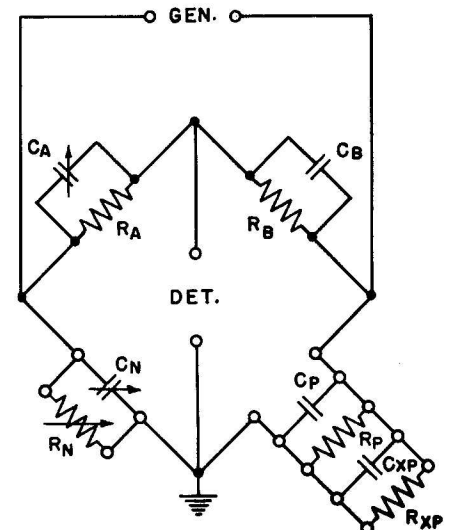

Figure 5. Substitution Parallel-Resistance Method.

may be made by means of the added decade resistor than by the DISSIPATION FACTOR dial. It is difficult, however, to make the dissipation factor balance on the bridge to better than 0.000001 (one millionth).

4.52 An external standard variable air capacitor may be used by connecting it across the UNKNOWN DIRECT terminals with the decade resistor in series in the ground lead. The unknown capacitor is then connected in parallel with both. The bridge is balanced for resistance by means of the DISSIPATION FACTOR dial with the decade resistor set at zero. The unknown capacitor is then disconnected, and the change in resistance is the setting of the decade resistor for the second balance. Equations (24) hold for this method also, C' being the capacitance of the external standard capacitor when the unknown capacitor is not connected.

4.6 PARALLEL RESISTANCE METHOD

4.61 The parallel capacitance and resistance of capacitors within the capacitance range of the bridge, 100 $\mu\mu$ f to 1.1 μ f at 1 kc and 100 to 1050 $\mu\mu$ f at other frequencies, may be measured directly by making the resistance balance on a decade resistor connected across the UNKNOWN SUBSTITUTION terminals in parallel with the internal standard capacitor as shown in Figure 4. The DISSIPATION FACTOR switch and dial must be set at zero. The resistance range is determined by that of the decade resistor.

$$C_{xp} = MC - 1.1 \tag{25}$$

$$R_{xp} = \frac{R}{M}$$

where the capacitance reading C must be increased by the parallel capacitance of the decade resistor. This capacitance varies with the number of decades and the

TYPE 716-C CAPACITANCE BRIDGE

settings of these decades between 10 and 40 $\mu\mu f^*$.

4.611 For a maximum setting of the decade resistor of 100 $k\Omega$, the lower limits of dissipation factor are 16 for a capacitance of 100 $\mu\mu f$, 1.6 for 1000 $\mu\mu f$, and 0.0016 for 1 μf .

4.62 The parallel capacitance and resistance limits may be extended by the substitution method shown in Figure 5. A balancing capacitor and resistor in parallel are connected across the UNKNOWN DIRECT terminals and a decade resistor of 100 $k\Omega$ maximum resistance is placed across the UNKNOWN SUBSTITUTION terminals. Using a balancing capacitance of 100 M $\mu\mu f$ and a balancing resistance of $\frac{100}{M} k\Omega$, the bridge will balance

with the CAPACITANCE dial at about 100 $\mu\mu f$ and the decade resistor set at about 100 $k\Omega$. The unknown capacitor is then connected across the UNKNOWN DIRECT terminals and the bridge rebalanced by increasing the setting of the standard capacitor and decreasing that of the decade resistor. The parallel capacitance and resistance of the unknown capacitor are

*D. B. Sinclair, "Radio Frequency Characteristics of Decade Resistors", General Radio EXPERIMENTER, Vol. XV, No. 6, December 1940.

$$C_{xp} = M(\Delta C) \quad (26)$$

$$R_{xp} = \frac{RR'}{M(\Delta R)}$$

where the change in capacitance ΔC must include the change in parallel capacitance of the decade resistor.* The smallest capacitance setting M of the RANGE SELECTOR switch which allows a capacitance balance should be used.

4.621 The largest resistance which can be detected corresponding to a change in resistance of 1 part in a million is 100 $kM\Omega$ with the RANGE SELECTOR switch set for M=1.

High resistances, large inductances, and parallel tuned circuits may be measured in a similar manner. An inductance will cause the setting of the standard capacitor to decrease when it is connected across the UNKNOWN DIRECT terminals. Either a larger balancing capacitor should be used or the inductor should be connected across the UNKNOWN SUBSTITUTION terminals. For the latter case the fixed and decade resistors should be transposed. Equations (26) still hold except that usually the RANGE SELECTOR switch is set for M=1. Inductance is calculated from Equation (14).

SECTION 5.0 OTHER USES

5.1 VOLTAGE LIMITS

5.11 The junctions of the ratio arms and of the capacitance arms, the latter being grounded, are brought out to the terminals marked DETECTOR in large capitals in the upper right corner of the panel. One winding of the shielded transformer is connected across the ratio arms and the other winding is connected to the terminals marked GENERATOR in large capitals in the upper left corner of the panel. This connection of the power supply produces maximum sensitivity of balance for the measurement of small capacitances.

5.12 The voltage that may be applied to the GENERATOR terminals is limited by the power dissipation of the ratio arms. All resistors except those used at 100 c will dissipate 0.5 watt. For the seven positions of the RANGE SELECTOR switch the values of the resistors used, their ratings in watts, volts, and milliamperes are given in Table IV. The ratings of the A arm resistors are the same as similar ones in the B arm. The maximum voltages which may be applied across the ratio arms and across the GENERATOR terminals are the same except at frequencies below 200 c. Below that frequency the magnetizing current of the transformer is the limiting factor. At 60 c the maximum voltage is 55v. The transformer has the same number of turns in both of its windings. It is safe to use any generator with a maximum output of 1 watt.

5.13 A much higher voltage can be applied to the unknown capacitor by connecting the power supply to the DETECTOR terminals. The limit is determined either by the maximum voltage of the standard capacitor, 700 volts peak, or by the maximum current of the B arm. The last line of Table IV gives these limits at frequency f_0 . At other frequencies these limits vary inversely with frequency.

5.14 The increased voltage that can be used across the DETECTOR terminals will tend to offset the lowered sensitivity of the bridge for this connection. Less power will be lost in the ratio arms and none in the transformer. This will shorten the time needed to attain temperature equilibrium of the bridge after the power is applied. Although the errors caused by these temperature changes are less than the limits given in Table I, they are sometimes annoying in substitution methods because they shift the initial balance.

5.2 FREQUENCY RANGE

5.21 The bridge will operate at all frequencies from 30 cycles to 300 kilocycles with the accuracy limits given in Table I, provided that the ratio of the frequency f applied to the bridge to the frequency f_0 indicated by the RANGE SELECTOR switch lies between 0.1 and 3. The capacitance range is unaffected by frequency except that only for $f_0 = 1$ kc does it extend to 1 μf . The dis-

GENERAL RADIO COMPANY

TABLE IV

RANGE SELECTOR	M f _o	1 100 c	1 1kc	10 1kc	100 1kc	1000 1kc	1 10 kc	1 100 kc
R _A	kΩ	200	20	20	20	20	2	.2
R _B	kΩ	200	20	2	.2	.02	2	.2
R _B	w	1	.5	.5	.5	.5	.5	.5
R _B	v	450	100	30	10	3	30	10
R _B	ma	2.2	5	16	50	160	16	50
GENERATOR	v	90	200	130	110	103	60	20
DETECTOR	v	700	700	250	80	25	250	80

sipation factor range is directly proportional to frequency. Its maximum value is, therefore, .056 for $f/f_0 = 0.1$ and 1.68 for $f/f_0 = 3$. The smallest detectable dissipation factor is similarly affected, being 0.000002 and 0.00006 respectively.

5.22 For substitution measurements the operating frequency f can be made 10 times the RANGE SELECTOR frequency f_0 before the accuracy limits of Table I are exceeded. This makes possible measurement at a frequency of 1Mc. The minimum dissipation factor is however raised to 0.0002. At this frequency some of the effects of residual impedances in the standard capacitor and the dissipation factor capacitors have begun to be serious. The series inductance and resistance of the standard capacitor is the same as for a Type 722-M Precision Condenser,* 0.06 μh and 0.02 Ω respectively. These residuals will produce an error⁺ of -0.3% in capacitance and -0.0002 in dissipation factor when measuring a capacitance of 1000 μmf by the substitution method of Section 3.2. The inductance in series with the dissipation factor capacitors is about 0.5 μh , which will produce an error of -0.8% in the dissipation factor reading at the level of $D = 0.05$.

5.23 A dissipation factor of 0.000001 (one millionth) is essentially the limit of sensitivity of the bridge. It requires, for accomplishment, complete freedom from extraneous voltages both in the amplifier and in the bridge itself. When power is taken from the local power supply at 60, 50, or 42 cycles, it is very difficult to prevent the electric and magnetic fields from the wiring and from motors from inducing considerable voltages in the bridge. Exposed leads to the balancing and unknown

capacitors pickup voltages from the electric field, while the shielded transformer may be affected by the magnetic field, even though it has a high-permeability case. The magnetic field usually fluctuates with wide limits so that even substitution methods are affected. Measurements under these conditions are rarely reliable to better than 0.000010 for dissipation factor. It is often advisable to use a frequency differing sufficiently from the power supply frequency so that these extraneous voltages can be removed by suitable filter circuits. Even a slight difference in frequency which produces a slow beat between the frequencies is sufficient, because then in order to balance the bridge it is only necessary to reduce to zero the amplitude of this beat.

5.3 MEASUREMENT OF DIELECTRICS

5.31 The dielectric constant and dissipation factor of a solid dielectric are obtained by applying suitable electrodes to the material and measuring its capacitance and dissipation factor by the method described in Section 3.2. Satisfactory results are obtained when the material is in the form of thin slabs. Electrodes may be cut from thin lead foil and fixed to the slab by a very thin coat of petrolatum. High conductivity silver paint also provides good electrodes, especially when the slabs are conditioned at high humidity because such paint is porous to water vapor. Electrodes should extend to the edge of the sample.

5.32 The dielectric constant of the material is

$$K = \frac{C_{xp}}{C_0} = \frac{11.30tC_x}{A} \quad (\mu mf, \text{ cm}) \tag{27}$$

$$K = \frac{4.45tC_{xp}}{A} \quad (\mu mf, \text{ in})$$

*See General Radio catalog for data.

⁺R. F. Field, "Substitution Measurements at Radio Frequencies", General Radio EXPERIMENTER, Vol. XIV, No. 12, May 1940.

TYPE 716-C CAPACITANCE BRIDGE

where C_0 is the air capacitance between the two electrodes. It is given by

$$C_0 = 0.0885 \frac{A}{t} \quad \mu\mu f \text{ (cm)} \quad (28)$$

$$C_0 = 0.2248 \frac{A}{t} \quad \mu\mu f \text{ (in)}$$

where A is the area of the electrodes and t the thickness of the slab.

Since this method neglects edge and ground capacitance, the calculated K may be too large by as much as 10%.

5.33 This error can be substantially reduced by the use of the following formulae*

$$C_p = C_{xp} - (C_e + C_g) \quad (29)$$

where

$$C_e = P (0.121 \log_{10} \frac{P}{t} - 0.114) \quad \mu\mu f \text{ (in)}$$

$$C_g = 0.123 \frac{A}{\sqrt{h}} + 0.78t \quad \mu\mu f \text{ (in)}$$

where C_p is the corrected capacitance to be used in the calculation of K , C_e is the edge capacitance in air, C_g is the capacitance of the high electrode to ground, P is the perimeter of the sample, and h is the height of the high electrode above the ground plane.

5.34 The Type 1690-A Dielectric Sample Holder** provides a more accurate and much more convenient method for making these measurements. Its use essentially eliminates connection errors as well as errors due to C_e and C_g . It may be used over the entire frequency range of the bridge and in conjunction with other suitable measuring circuits, to at least 100 Mc.

5.4 MEASUREMENT OF DIRECT CAPACITANCE

5.41 The direct capacitance[†] between two terminals may be separated from the capacitance of these terminals to a surrounding shield by connecting this shield to the junction of the ratio arms and balancing the bridge by the direct reading method of Section 3.1. The bridge reads too high in dissipation factor because one of the

terminal capacitances is connected across ratio arm B. Even the substitution method of Section 3.2 does not give the correct value for dissipation factor because the terminal capacitances placed across ratio arm A are not the same for the two balances of the bridge.

5.411 The terminal capacitance placed across a ratio arm affects slightly the resistance of that arm, because of the parallel resistance which represents its dielectric loss. Hence in the substitution method an error of perhaps $0.1 \mu\mu f$ may occur in the capacitance measurement. While such an error is generally negligible, it is large enough to prevent the measurement of such small direct capacitances as the grid-to-plate capacitance of a screen-grid vacuum tube. The error is always in the direction to give too small a capacitance. Its presence is frequently detected by the fact that the calculated capacitance is negative. This error can be greatly reduced by disconnecting the capacitor on the ground side. This makes the terminal capacitance

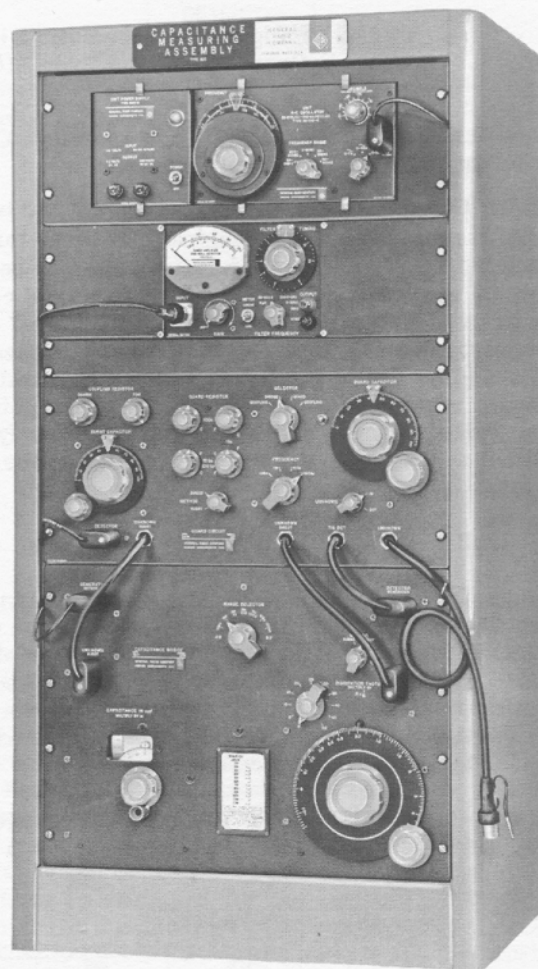

Figure 6. View of Type 1610-B Capacitance Measuring Assembly: Type 1210-C Unit R-C Oscillator with Type 1203-B Unit Power Supply, Type 1232-A Tuned Amplifier and Null Detector, Type 716-P4R Guard Circuit, and Type 716-CR Capacitance Bridge.

*See ASTM Specification D-150.

**I.G. Easton, "A Sample Holder for Solid Dielectric Materials," General Radio EXPERIMENTER, Vol. XXVI, No. 3, August, 1951. See also General Radio catalog and ASTM Specification D-150.

†R. F. Field, "Determination of the Edge Correction in the Measurement of Dielectric Constant", Proc. ASTM Vol. 37, Part II, 1937, pp. 655-660.

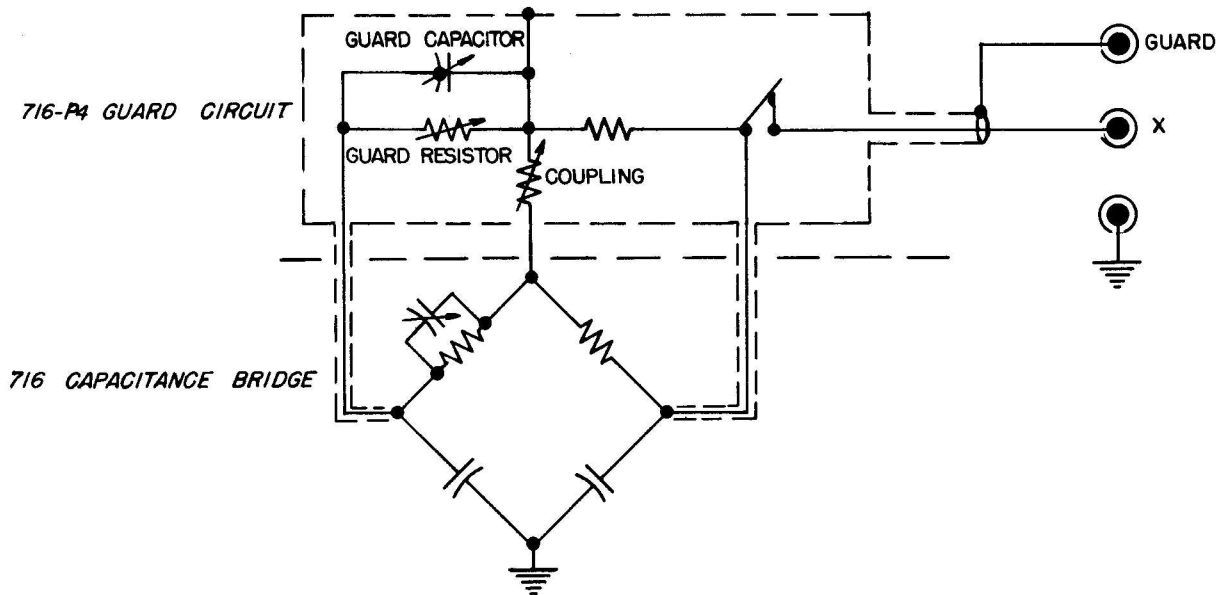

Figure 7. Schematic Diagram of the Type 716-P4 Guard Circuit Connected to the Type 716-C Capacitance Bridge for Direct Method.

placed across the A arm for the two balances differ only by the direct capacitance being measured.

5.42 Guard Circuits: The errors produced by connecting the shield or third terminal of a three terminal capacitor to the junction of the ratio arms may be eliminated by connecting this terminal to a guard circuit, such as the Type 716-P4 Guard Circuit. Figure 7 shows, in simplified form, the Type 716-C Bridge connected to a Type 716-P4 Guard Circuit. The third terminal of the capacitor under test is connected to the guard point, and the undesired terminal capacitances are effectively eliminated from the measurement by balancing the guard circuit.

5.5 GUARD ELECTRODES

5.51 The use of the guard circuit described in Section 5.42 makes it possible to eliminate all of the errors discussed in Section 5.3 in the measurement of dielectrics. The slab of dielectric is placed in a shielded compartment insulated from ground and having the electrodes connected as in Figure 8. The measuring electrodes are circular and the guard electrode annular.

For a detailed description of electrode arrangements the reader is referred to ASTM Specification D-150.

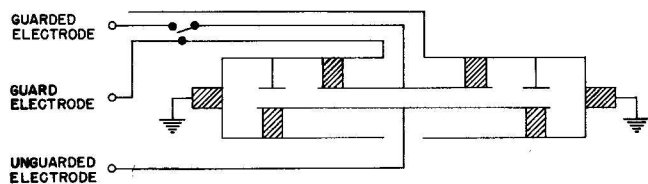

Figure 8. Dielectric Cell and Shielded Connections.

5.52 The measuring electrodes are usually referred to as the guarded and unguarded electrodes. The three direct capacitances between the three electrodes depend solely on the geometric configuration of the electrodes and on the dielectric constant of the intervening dielectric. They are independent of the voltages applied to the three electrodes, except as the voltage gradient in the dielectric affects the dielectric constant and dissipation factor. Such an effect of voltage gradient is negligible in most solid dielectrics, except under conditions of high humidity. It is very noticeable in some liquids.

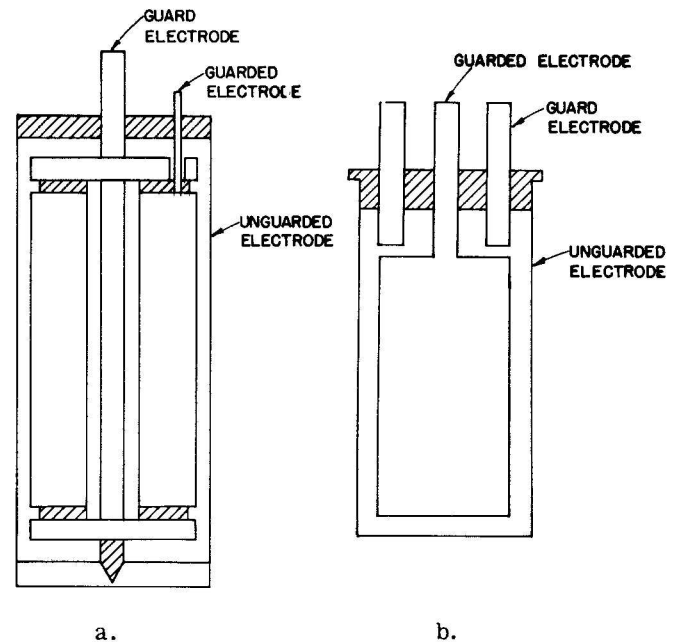

Figure 9. Liquid Dielectric Cells.

TYPE 716-C CAPACITANCE BRIDGE

Hence in most cases the two measuring electrodes and also generator and detector can be transposed without affecting the results.

5.53 The effect of voltage gradient is eliminated when at balance the guarded and guard electrodes are brought to the same potential. This also removes the danger of breakdown between these two electrodes, which would be likely to occur because of their close spacing. For the Type 716-P4 Guard Circuit the guarded electrode should be grounded, with the normal connection of generator and detector, since at balance the guard point is brought to ground potential.

5.54 The dielectric cell shown in Figure 8 could be used for measuring the dielectric constant and dissipation factor of a liquid provided it were made tight. It is usual, however, to make the electrodes cylindrical and either place guard cylinders at both ends as shown in Figure 9a, or at only one end as shown in Figure 9b.

The single ended type shown in Figure 9b is preferable because the liquid does not touch the solid insulation. This type of construction provides a greater capacitance for a given amount of liquid.

5.6 POLARIZING VOLTAGE.

A suggested circuit for the application of polarizing voltage up to 1000 volts dc to capacitors being measured is shown in Figure 11.

Although the polarizing voltage is introduced at the DETECTOR terminals, most of the voltage appears across the unknown capacitor, since its impedance is much higher than the resistance of the series ratio arm, R_B . The circuit values given in Figure 11 are for a test frequency of 1000 cps, and should be modified for use at other frequencies. Parallel capacitors are shown because there is not enough room in a Type 874-X Insertion Unit for a 0.01- μ f, 1000-v capacitor. Recommended capacitors are Centralab Type TDBC or equivalent.

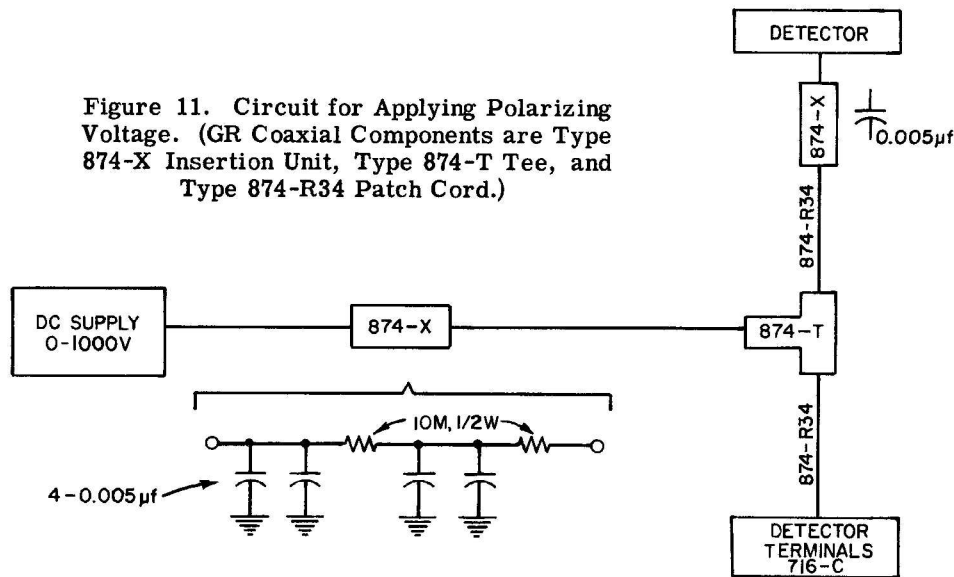

Figure 11. Circuit for Applying Polarizing Voltage. (GR Coaxial Components are Type 874-X Insertion Unit, Type 874-T Tee, and Type 874-R34 Patch Cord.)

SECTION 6.0 CONSTRUCTION

6.1 ELECTRICAL CIRCUIT

6.11 The wiring diagram of the Type 716-C Capacitance Bridge is shown in Figure 10. All features of the design are directed toward making the bridge direct reading in capacitance and dissipation factor over the entire capacitance and frequency range to the greatest possible accuracy. The most important features of the design are the complete shielding of both ratio arms and transformer, the ability to place the dissipation factor capacitors across either ratio arm, and the compensation for capacitance of the various ratio arms so that the storage factors $R_A \omega C_A$ and $R_B \omega C_B$ of the pairs of ratio arms are exactly equal and approximately constant for all settings of the RANGE SELECTOR switch.

6.2 ADJUSTMENTS

6.21 Standard Capacitor: The standard capacitor C-21 has been adjusted to be direct reading in capaci-

tance from 100 to 1150 $\mu\mu$ i to an accuracy of 1 $\mu\mu$ f. The pair of plates at each end of the stator stack control the internal consistency of this calibration and are adjusted before the capacitor is mounted in the bridge. A movable plate mounted on the frame changes the zero capacitance of the capacitor and is adjusted to make the bridge read correctly in capacitance. This compensates for the capacitances of the UNKNOWN SUBSTITUTION terminals and the wiring to them and for the leakage impedances of the shielded transformer. The capacitance of 1.1 $\mu\mu$ f of the UNKNOWN DIRECT terminals is not compensated.

6.211 The dissipation factor of this capacitor varies from 0.00004 at 1000 $\mu\mu$ f to 0.0004 at 100 $\mu\mu$ f, corresponding to a figure of merit DC of 0.04 $\mu\mu$ f. These values of dissipation factors are not compensated by the adjustment described in Section 6.252.

6.22 Dissipation Factor Capacitors: The dissipation factor scale of the air capacitor C-16 corresponds exactly to capacitance differences measured from an arbitrary zero chosen near the minimum capacitance setting, such that the dissipation factor limits of -0.0015 and 0.06 appear. The decade capacitors C-22 are mica units similar to Type 380 Decade Capacitor Units, so chosen that each step is $398 \mu\text{mf}$, giving a dissipation factor of 0.05 for each step with an accuracy of $\pm 1\%$.

6.221 The decade and air capacitors are connected across either the A or B arm of the bridge by means of the METHOD switch S-2, being placed across the A arm in the DIRECT position and across the B arm in the SUBSTITUTION position.

6.23 Shielded Transformer: The shields around both windings are complete and are connected to the winding to eliminate all terminal capacitances. The leads are brought out by means of Teflon concentric cable. A third shield between the two winding shields is connected to the transformer case and to the main insulated shield of the bridge, which in turn is connected to the junction of the ratio arms. The various shields are insulated from each other by Teflon tape. The capacitance between these shields and the bridge winding shield is placed across the B ratio arm and amounts to about $110 \mu\text{mf}$. It will change slightly with temperature.

6.231 In spite of the care taken to obtain complete shielding of the generator winding from the bridge winding, enough capacitive coupling remains to introduce appreciable errors on the 100-kc range. The effect of this coupling is neutralized by applying a compensating voltage across the DETECTOR terminals. This voltage is obtained by capacitive coupling through the double-stator capacitor C-20 to the opposite ends of the generator winding shield whose middle point is grounded and that has induced in it the voltage of one turn. It is by this device that the bridge accuracy is maintained up to a frequency of 1 Mc.

6.24 Ratio Arms: The ratio arms are all mounted on a double arm switch S-1, which controls both the choice of ratio arms and the compensating capacitors. The switch is made of mica-filled phenolic so that the parallel resistance representing its dielectric losses will not be an appreciable shunt on the $200 \text{ k}\Omega$ ratio arms at the lowest operating frequency of 30 c.

6.25 Compensating Capacitors: With the DISSIPATION FACTOR switch and dial set at zero, the METHOD switch set at DIRECT, and the RANGE SELECTOR switch set at any position for which the capacitance multiplier $M = 1$, the total capacitance across the A arm is $205 \mu\text{mf} + 5\%$. This is made up of roughly $65 \mu\text{mf}$ from the dissipation factor capacitors C-16 and C-22, $90 \mu\text{mf}$ from the wiring of all the resistors and capacitors in the A arm, and $25 \mu\text{mf}$ each from the zero adjustment capacitor C-17 and whichever of the variable air capacitors C-1

to C-7 is in circuit, each being set at about half scale. This capacitance of $205 \mu\text{mf}$ is balanced in the B arm by $60 \mu\text{mf}$ from the wiring of all the resistors and capacitors in the B arm, $110 \mu\text{mf}$ from the transformer T-1, and $35 \mu\text{mf}$ from mica capacitor C-10. When the range selector is set on the other capacitance multipliers, 10, 100, 1000, mica capacitors C-11 to C-13 with capacitances of 0.0019, 0.021 and $0.21 \mu\text{f}$ respectively are added.

6.251 When the METHOD switch is set at SUBSTITUTION, the zero capacitance of $65 \mu\text{mf}$ of the dissipation factor capacitors C-16 and C-22 is added across the B arm. This transferred capacitance is balanced in the A arm by a $100 \mu\text{mf}$ mica capacitor C-19 and a variable air capacitor C-18 set at approximately $30 \mu\text{mf}$. The total capacitance across both arms is thus increased to $270 \mu\text{mf}$.

6.252 The seven air capacitors C-1 to C-7 associated with the seven positions of the RANGE SELECTOR switch are adjusted* by connecting in turn across the UNKNOWN DIRECT terminals suitable standard capacitors of known capacitance and dissipation factor, such that a capacitance balance is obtained at each position for settings of the internal standard capacitor of approximately 100 and $1000 \mu\text{mf}$. With the DISSIPATION FACTOR dial set at the known dissipation factor decreased by that of the internal standard, the bridge is balanced for dissipation factor by the compensating air capacitors with the internal standard set at $1000 \mu\text{mf}$ and then checked with the standard set at $100 \mu\text{mf}$. In general these check readings will agree very closely except at 100 kc. At this frequency the readings are brought into agreement by adjustment of the double stator capacitor C-20 connected to the transformer shield. The METHOD switch is then set at SUBSTITUTION, the RANGE SELECTOR switch set for $M = 1$ and $f_0 = 1 \text{ kc}$, and the DISSIPATION FACTOR dial set at minus the known dissipation factor plus that of the internal standard. The bridge is then balanced for dissipation factor by the compensating air capacitor C-18 associated with the METHOD switch.

6.253 Changes in the inter-shield capacitances of the shielded transformer and in the wiring capacitances caused by temperature changes will affect equally the dissipation factor readings on all settings of the RANGE SELECTOR switch. These changes can be compensated by adjustment of air capacitor C-17, using for measurement any capacitor of known dissipation factor. If none is available, the dissipation factor of any capacitor having a capacitance between 100 and $1000 \mu\text{mf}$ can be measured by the substitution method of Section 3.2 and then used as a standard.

*Relative humidity inside the bridge should be kept below 40% for some time before, and while, making the adjustments outlined in paragraph 6.252.

PARTS LIST

PART NO.
(NOTE A)

RESISTORS (NOTE B)			
R1	200k	±0.05%	REPR-17-E
R2	20k		510-361
R3	20k		510-361
R4	20k		510-361
R5	20k		510-361
R6	2k		510-341
R7	200		500-30E
R9	200k	±0.05%	REPR-17-E
R10	20k		510-361
R11	2k		510-341
R12	200		500-30E
R13	20		510-340
R14	2k		510-341
R15	200		500-30E

CAPACITORS (NOTE C)			
C1	50		COA-2
C2	50		COA-2
C3	50		COA-2
C4	50		COA-2
C5	50		COA-2
C6	50		COA-2
C7	50		COA-2
C10	35		COM-20B
C11	0.0019 μf		505
C12	0.021 μf		505
C13	0.210 μf		505
C16	500		539-405
C17	50		COA-2
C18	50		COA-2
C19	0.0001 μf ±10%		COM-20B
C20	11		846-400
C21	1100		722-402
C22			980-400

S1	SWITCH	716-38
S2	SWITCH	SWRW-33
T1	TRANSFORMER	578-402

NOTES:

(A) Type prefixes for resistors and capacitors are as follows:

COA - Capacitor, air
COM - Capacitor, mica
REPR - Resistor, precision

(B) All resistances are in ohms except as otherwise indicated by k (kilohms).

(C) All capacitances are in micromicrofarads except as otherwise indicated by μf (microfarads).

When ordering replacement components, be sure to include complete description as well as Part Number. (Example: R85, 51k ±10%, 1/2w, REC-20BF.)

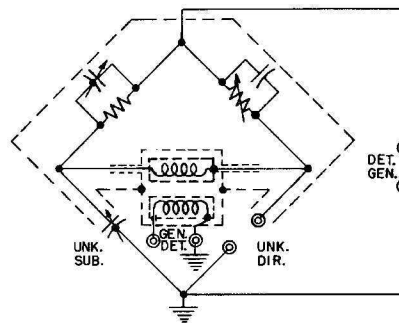
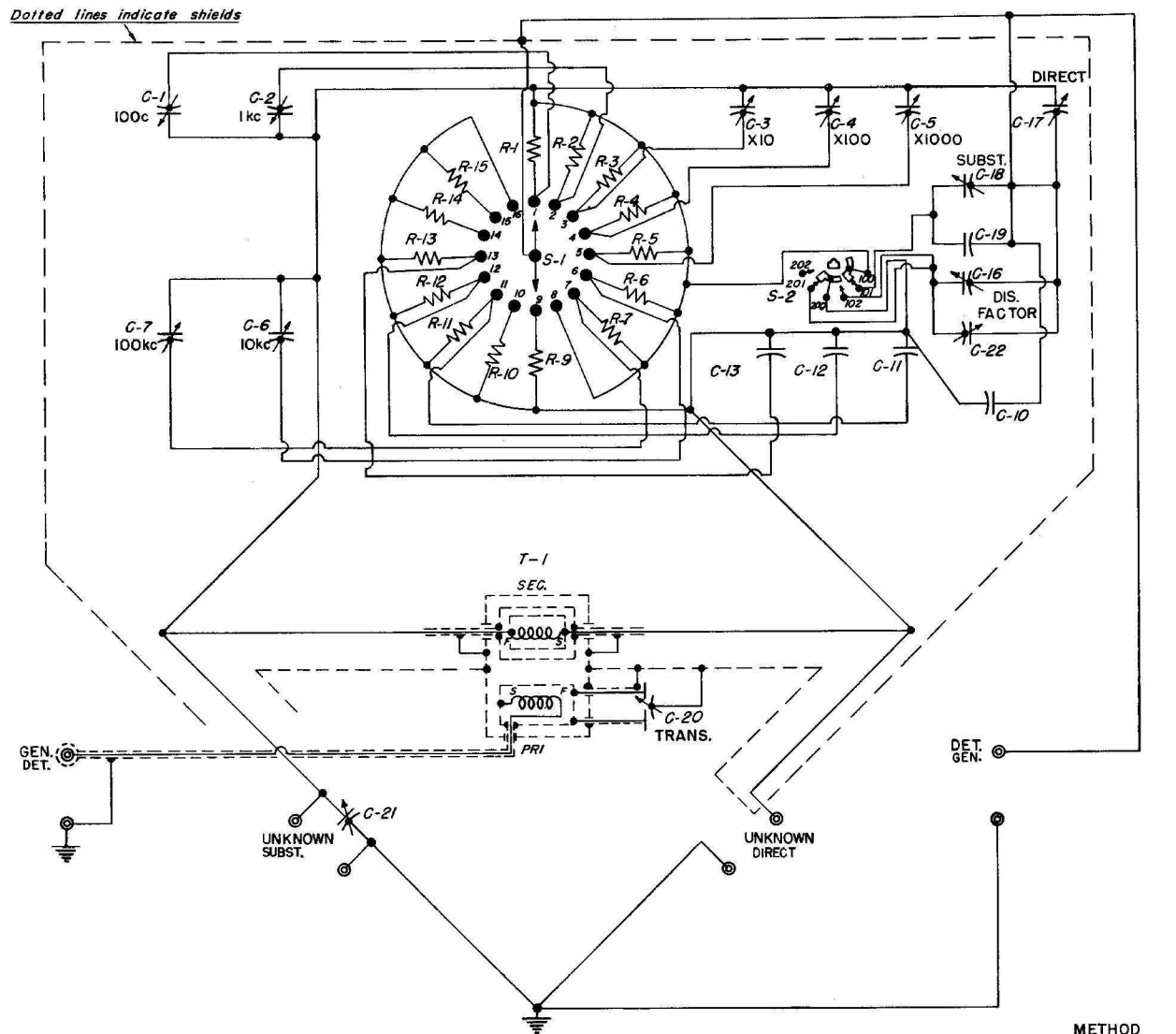

**ELEMENTARY
SCHEMATIC
DIAGRAM**

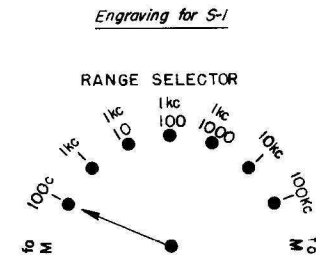

Figure 10. Wiring Diagram for Type 716-C Capacitance Bridge.



TYPE 716-CS1 CAPACITANCE BRIDGE

Supplement to Type 716-C Operating Instructions

ONE MEGACYCLE USE

The Type 716-CS1 has been adjusted and calibrated to have the same accuracy at 1 Mc as does the Type 716-C at lower frequencies. The dissipation factor of the standard capacitor and the 1 $\mu\mu\text{f}$ capacitance of the DIRECT terminals have been included in the adjustments, so the corrections for these terms mentioned in paragraphs 3.122 and 3.125 of the Type 716-C book need not be made. The scale correction table on the panel or a worm correction* may be used for both direct and substitution measurements.

OTHER FREQUENCIES

When the corrections for residual bridge parameters given in the accompanying charts are applied, essentially the same accuracy as at 1 Mc will be maintained from 0.1 to 3 Mc and up to 55% D. Above 3 Mc, the results may be less accurate since the charts are constructed for average residuals.

CORRECTIONS FOR RESIDUAL BRIDGE PARAMETERS

The corrections for the effective residual bridge parameters are given in chart form to simplify their application. The corrections in Chart I are for the effective series resistance of the precision capacitor. Chart III is for the effective series inductance of the precision capacitor. Charts II and IV are for the effective series inductance of the dissipation factor capacitors.

In all the charts, the ordinates and the lines are in the same terms as read on the bridge dials (except that in Charts III and IV the corrections are in percent of C). Note that D is multiplied by 0.01 after corrections are added. The abscissae are functions of frequency so chosen as to yield 45-degree lines. These lines are labeled at the logarithmic intercepts to aid in interpolation.

Corrections plotted against a function of frequency in megacycles minus one are negative below and positive above one megacycle. The bridge has been adjusted and calibrated so that these corrections are zero at 1 Mc.

Corrections versus frequency squared are positive at all frequencies. When D or ΔD is small, these corrections are negligible at 1 Mc.

GENERAL

Substitution measurements are more accurate and require one less correction than direct. The capacitance level should be so chosen that the balance with the unknown connected occurs near 100 $\mu\mu\text{f}$, thus minimizing the corrections that are a function of ΣC .

In the Type 716-C Operating Instructions, general equations are valid for the Type 716-CS1 when corrected

*See General Radio Catalog for additional information.

C and D values are used, but equations containing correction terms should not be used.

The bridge measures effective capacitance and dissipation factor at its terminals. When leads are used, the measured C_e and D_e values will be greater than the true C and D of the unknown:

$$C_e = \frac{C}{1 - \omega^2 LC^2} \approx C + \omega^2 LC^2 \quad D_e = D + R_0 \sqrt{f} \omega C$$

where L is the equivalent series lead inductance, R_0 the equivalent series resistance at 1 Mc and f is expressed in Mc.

Approximate values of L and R_0 are 0.19 μh and 0.038 Ω for a pair of parallel No. 16 bare wires 6 inches long, at three-quarter inch spacing. In addition to these high frequency lead corrections allowance must also be made for lead capacitance, as with any two-terminal bridge.

A simple way to find the C and D corrections (or to determine L and R) for any set of leads is to measure a physically small capacitor, of the same value as the unknown, at the bridge terminals, with and without the leads, and at the end of the leads.

Apply corrections from charts as shown in the following table, after correcting for leads.

Direct Measurements

Chart	Enter At		Correction	Add To
	Line	Abscissa	Ordinate	
I	C	$M_c^{3/2} - 1$	D	$\frac{f}{f_0} D^*$
II	D_0 D	$M_c^2 - 1$ M_c^2	D D	
III	C	$M_c^2 - 1$	%C	C
IV	D	M_c^2	%C	

Substitution Measurements

I	ΣC	$M_c^{3/2} - 1$	D	$f/f_0 \times C' \times \Delta D^*$
II	ΔD	M_c^2	D	
III	ΣC	$M_c^2 - 1$	%C	ΔC
IV	ΔD	M_c^2	%C	

*Multiply by 0.01 after corrections are added.

Where C = CAPACITANCE reading
 ΣC = $C' + C$
 ΔC = $C' - C$
 D = DISSIPATION FACTOR switch plus dial reading
 ΔD = $D - D'$

CHART I

ADD TO $\frac{F}{F_0} D$ or $\frac{F}{F_0} \times \frac{D}{C} \Delta D$

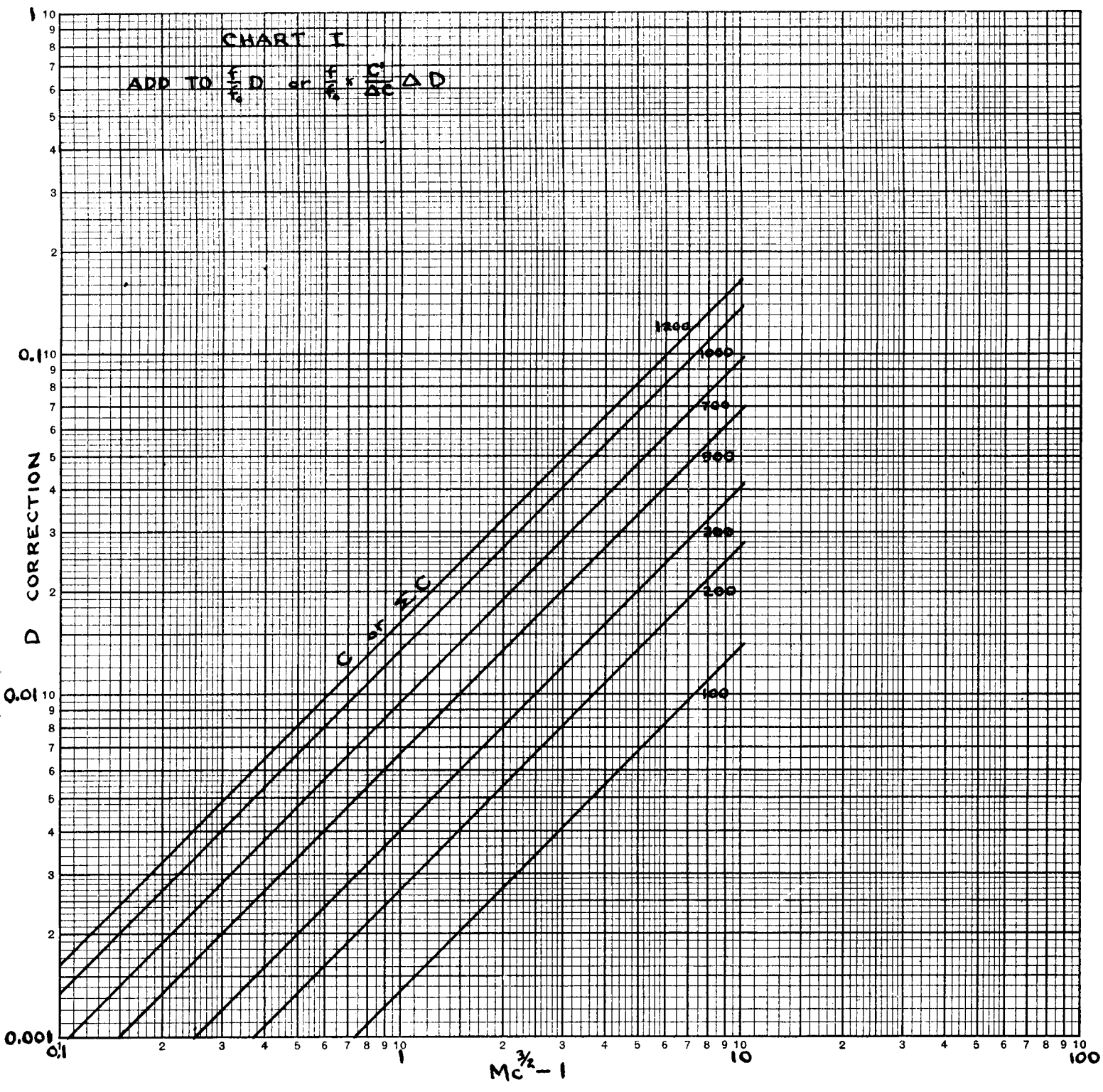

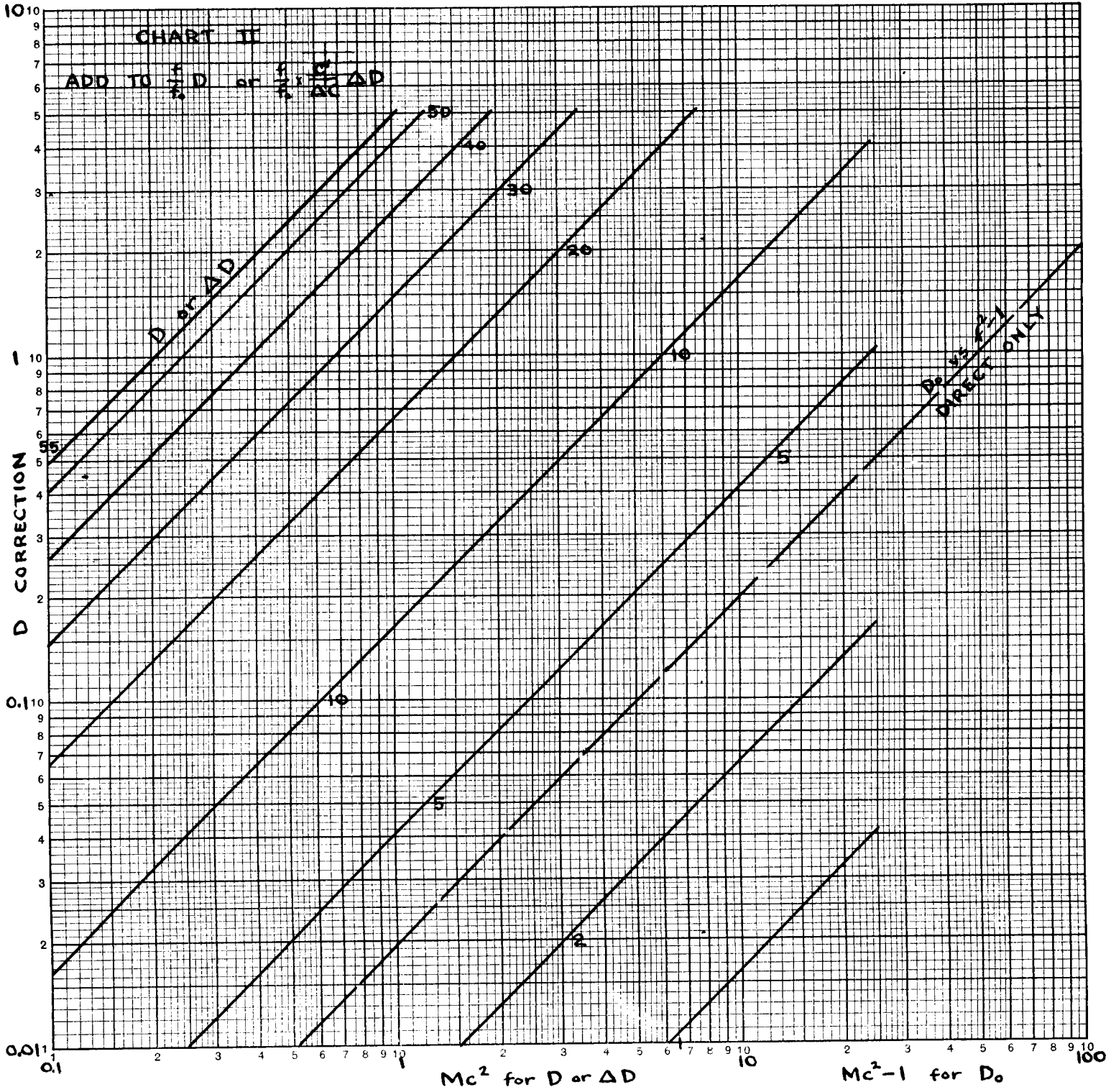

CHART III
ADD TO C or ΔC

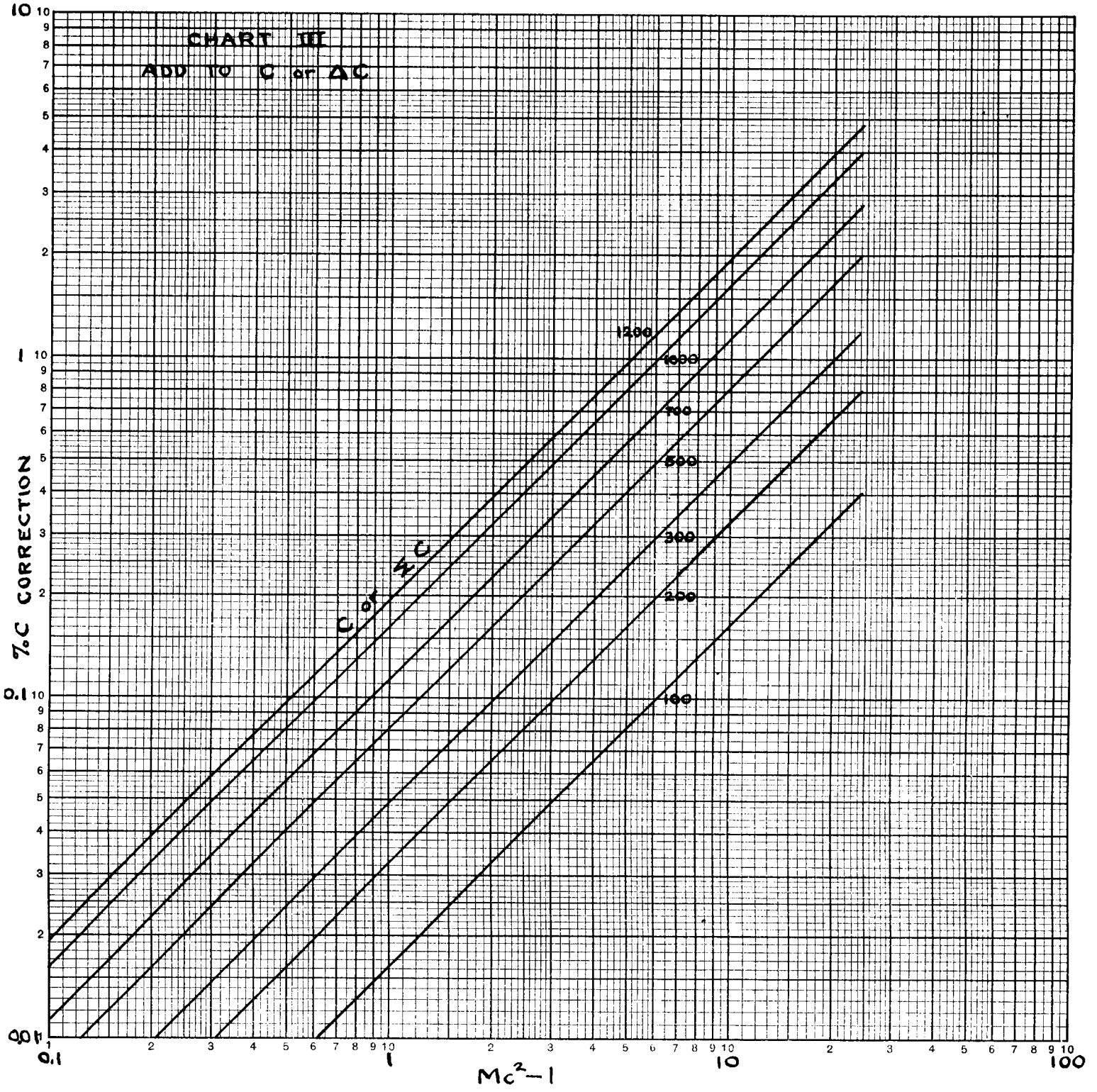
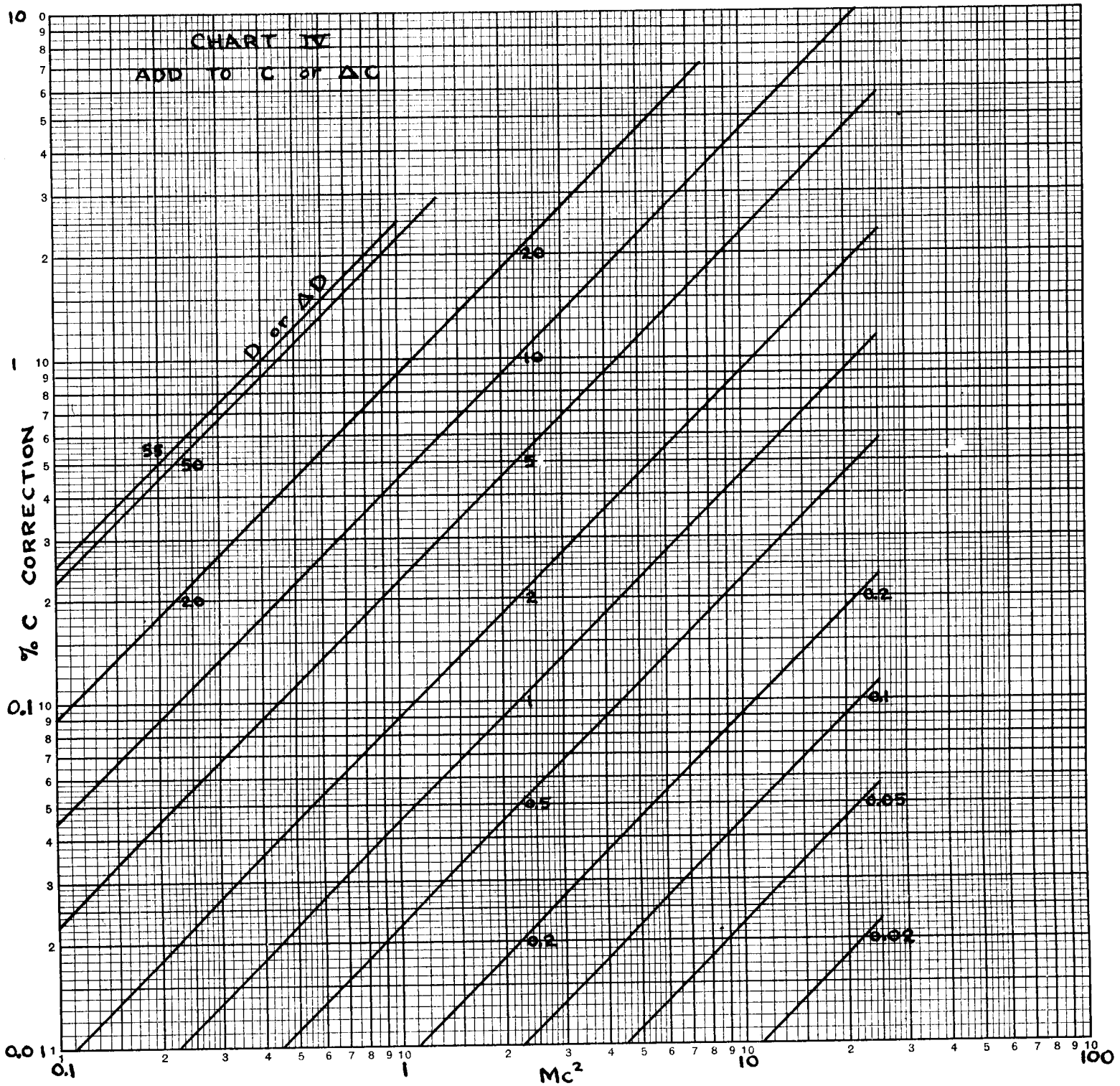
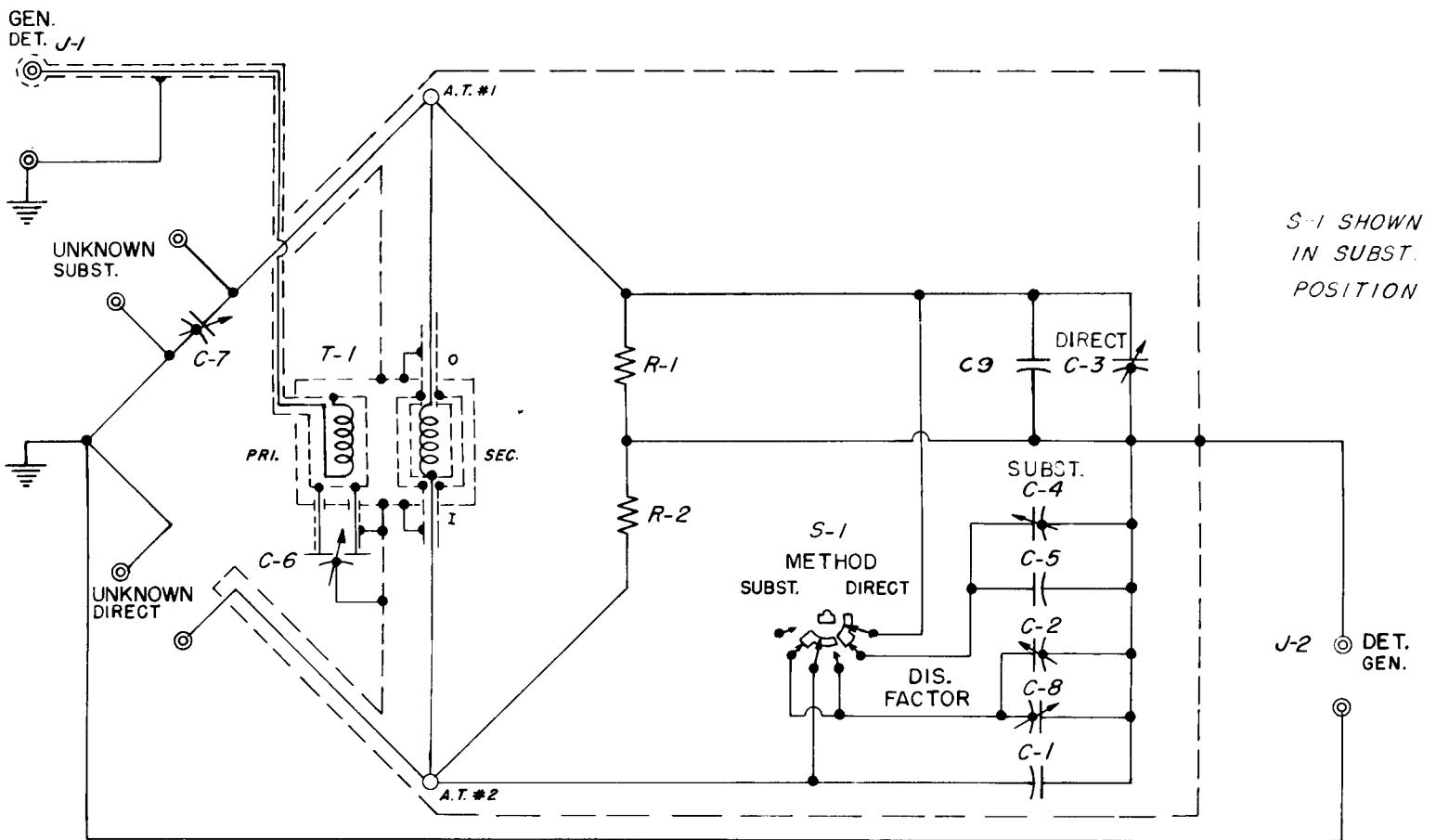
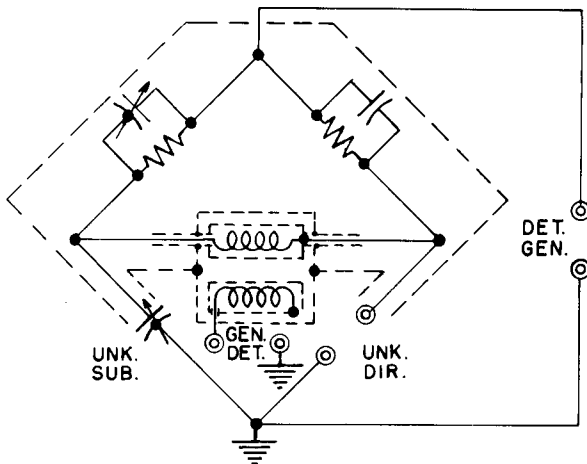

CHART IV
ADD TO C OF ΔC





Wiring Diagram for Type 716-CS1 Capacitance Bridge



Elementary Schematic Diagram

PARTS LIST

RESISTORS

R-1 = 20 Ohms 510-340
 R-2 = 20 Ohms 510-340

CAPACITORS

C-1 = 35 μf Dub 5W
 C-2 = 500 μf 539-405
 C-3 = 50 μf COA-2
 C-4 = 50 μf COA-2
 C-5 = 0.0001 μf +10% Dub 5W
 C-6 = 11 μf GR 846-400
 C-7 = 1100 μf 722-NS17
 C-8 = 380-400
 C-9 = 50 μf +10% Dub 5W

S-1 = Switch SWRW-33

T-1 = Transformer 578-402CS1

GENERAL RADIO COMPANY
 WEST CONCORD, MASSACHUSETTS

GENERAL RADIO COMPANY

WEST CONCORD, MASSACHUSETTS

EMerson 9-4400

CLearwater 9-8900

DISTRICT OFFICES

NEW YORK

Broad Ave. at Linden, Ridgefield, N. J.
Telephone N.Y. WOrth 4-2722
N.J. WHitney 3-3140

PHILADELPHIA

1150 York Rd., Abington, Penna.
Telephone HAncock 4-7419

WASHINGTON

8055 13th St., Silver Spring, Md.
Telephone JUniper 5-1088

CHICAGO

6605 West North Ave., Oak Park, Ill.
Telephone VillAge 8-9400

LOS ANGELES

1000 N. Seward St., Los Angeles 38, Calif.
Telephone HOLlywood 9-6201

SAN FRANCISCO

1186 Los Altos Ave., Los Altos, Calif.
Telephone WHitecliff 8-8233

CANADA

99 Floral Pkwy., Toronto 15, Ont.
Telephone CHerry 6-2171

REPAIR SERVICES

EAST COAST

General Radio Company
Service Department
22 Baker Ave., W. Concord, Mass.
Telephone EMerson 9-4400

NEW YORK

General Radio Company
Service Department
Broad Ave. at Linden, Ridgefield, N. J.
Telephone N.Y. WOrth 4-2722
N.J. WHitney 3-3140

MIDWEST

General Radio Company
Service Department
6605 West North Ave., Oak Park, Ill.
Telephone VillAge 8-9400

WEST COAST

General Radio Company
Service Department
1000 N. Seward St.
Los Angeles 38, Calif.
Telephone HOLlywood 9-6201

CANADA

Bayly Engineering, Ltd.
First Street, Ajax, Ontario
Telephone Toronto EMpire 2-3741